

AFL3-W07A-BT

Intel® Celeron® N2807 (Dual Core, 1.58 GHz)

AFL3-08A-BT

Intel® Celeron® J1900 (Quad Core, 2.0 GHz)



Features

- W7"~8.4" light industrial interactive panel PC
- 9 V ~ 30 V wide range DC input with lockable DC jack
- Selectable AT/ATX power mode
- Built-in speakers
- One mSATA slot
- IP64/IP65 compliant front panel
- IEI One Key Recovery solution allows you to create rapid OS backup and recovery (suggested with over 4GB storage capacity)



Specifications

Model		AFL3-W07A-BT	AFL3-08A-BT
LCD	Size	7"	8.4"
	Resolution	1024 x 600 (16:9)	800 x 600 (4:3)
	Brightness (cd/m ²)	500	450
	Contrast Ratio	700:1	600:1
	LCD Color	16.2M	16.2M
	Pixel Pitch (mm)	0.0635 (H) x 0.1905 (V)	0.213 (H) x 0.213 (V)
	Viewing Angle (H-V)	150° / 145°	160° / 140°
	Backlight MTBF(hrs)	20000 hrs	50000 hrs
Touch	Touch Screen	Projected capacitive with USB interface (anti-UV / anti-glare coating)	5-wire resistive with RS-232 interface (anti-glare coating) Projected capacitive with USB interface (anti-UV / anti-glare coating)
	Touch Controller	EETI EXC3160	PenMount DMC 9000/EETI EXC3146
Motherboard	CPU	Intel® Celeron® N2807 (dual core, 1.58 GHz)	Intel® Celeron® J1900 (quad core, 2.0 GHz)
	RAM	2GB DDR3L onboard RAM	One 204-pin 2 GB 1333MHz single-channel, 2GB DDR3L SO-DIMM pre-installed (system max. 8GB)
	Ethernet	2 x PCIe GbE by RTL8111HN-CG	2 x PCIe GbE by RTL8111HN-CG controller
	Audio Codec	ALC892	ALC892
Storage	mSATA		
I/O Ports & Switch	2 x RS-232 COM port (DB-9 connector) 2 x USB 3.2 Gen 1 (5Gb/s) 2 x GbE LAN 1 x Power switch 1 x Reset button 1 x AT/ATX switch 1 x 9-30V Lockable power jack		1 x RS-232 COM port (RJ-45 connector) 1 x RS-232/422/485 COM port (DB-9 connector) (RI/5V/12V) 2 x USB 3.2 Gen 1 (5Gb/s) 2 x RJ-45 for GbE LAN 1 x Power switch 1 x Audio port (line-out) 1 x Reset button 1 x AT/ATX switch 1 x 9-30V DC Lockable power jack
	Audio	AMP 2W (internal speaker, left channel output)	AMP 2W + 2W (internal speaker)
Camera and Microphone	N/A		2-megapixel with low light function, digital microphone
Wireless & Bluetooth	IEEE 802.11 a/b/g/n/ac, Bluetooth V4.0 half-size mini-PCIe slot (PCIe/USB signal)		IEEE 802.11a/b/g/n/ac half-size mini-PCIe slot (PCIe signal)
OSD Function	Software OSD		
Physical	Front Panel Construction	PC + ABS Plastic	
	Mounting	Panel, Wall, Stand, Arm, Rack VESA 75mm x 75mm	
	Color	Black C	
	Dimensions (WxHxD) (mm)	191 x 127 x 43	233 x 175 x 50
	Cut-out Dimensions (WxH) (mm)	182 x 111	207 x 143
	Net/Gross Weight (kgs)	0.73/1.81	0.8/2.44
Environment	Operating Temperature (°C) (Ambient with air flow)	-20°C~50°C	-15°C~55°C
	Storage Temperature (°C)	-20°C~60°C	-20°C~65°C
	Humidity	10% to 95% (non-condensing)	
	IP Level	IP 65 compliant front panel	IP 64 compliant front panel
	Safety&EMC	CE / FCC	
Power	Thermal Solution	Fanless	
	Power Requirement	9 V ~ 30 V	
	Power Consumption	12V@2.08 (Intel® N2807 CPU with 2GB 1333 MHz DDR3L memory)	12V@2A (Intel® J1900 CPU with 2GB 1333 MHz DDR3L memory)

Ordering Information

Part No.	Description
AFL3-W07A-BT-N1/PC/2G-R20	7" 500 cd/m ² 1024 x 600 HD fanless panel PC with Intel® Celeron® N2807 dual core 1.58 GHz, 802.11a/b/g/n/ac, projected capacitive touch screen, on-board 2GB DDR3L RAM, R20
AFL3-W07A-BT-N1/PC/2G/MF-R20	7" 500 cd/m ² 1024 x 600 HD fanless panel PC with Intel® Celeron® N2807 dual core 1.58 GHz, 802.11a/b/g/n/ac, projected capacitive touch screen, on-board 2GB DDR3L RAM, Mifare RFID, R20
AFL3-08A-BT-J1/PC/2G-R14	8.4" 450cd/m ² SVGA fanless panel PC with Intel® Celeron® J1900 quad core 2 GHz, 802.11a/b/g/n/ac wireless module, projected capacitive touch screen, 2GB DDR3L RAM, R14
AFL3-08A-BT-J1/R/2G-R14	8.4" 450cd/m ² SVGA fanless panel PC with Intel® Celeron® J1900 quad core 2 GHz, 802.11 a/b/g/n/ac wireless module, resistive touch window, 2GB DDR3L RAM, R14
AFL3-08A-BT-J1/PC-R14	8.4" 450cd/m ² SVGA fanless panel PC with Intel® Celeron® J1900 quad core 2 GHz, 802.11 a/b/g/n/ac wireless module, projected capacitive touch screen, w/o RAM for ATO only , with AG, 2-megapixel camera, microphone, R14
AFL3-08A-BT-J1/PC/2G/MF-R14	8.4" 450cd/m ² SVGA fanless panel PC with Intel® Celeron® J1900 quad core 2 GHz, 802.11 a/b/g/n/ac wireless module, projected capacitive touch screen, 2GB DDR3L RAM, Mifare RFID, with AG, 2-megapixel camera, microphone, R14

Options

Item	AFL3-W07A-BT	AFL3-08A-BT
Panel Mounting Kit	AFL3PK-W07A-R11	AFL3PK-08A-R10
Wall Mounting Kit	AFLWK-12	AFLWK-12
Rack Mounting Kit	AFL3RK-W07A-R11	AFL3RK-08A-R10
Arm	ARM-11-RS/ARM-31-RS	ARM-11-RS/ARM-31-RS
Stand	STAND-B08/STAND-100-RS	STAND-B08/STAND-100-RS
V-Stand	VSTAND-A07-R11	VSTAND-A10-R11
Magnetic Card Reader	AFL3P-W7MSR-U-R10	AFL3P-W10MSR-U-R10
Barcode Scanner	N/A	AFL3-2D-R11
RFID Reader (13.56 MHz Mifare Type)	AFL3-W07A-BT-N1/PC/2G/MF-R12	N/A (Customized by project base)
*OS: Win 7 Embedded (64-bit)	AFL3-W07A-BT-WES7P64-R11 (for PCAP touch)	AFL3-W07A-BT-WES7P64-R11 (for PCAP touch) AFL3-W07A-BT-WES7E64-R11 (for Resistive touch)
*OS: Win 8 Embedded (64-bit)	AFL3-W07A-BT-WE8S64-R10	
*OS: Win 10 IOT Enterprise (64-bit)	AFL3-W07A-BT-W10E64-E-R11	

*OS image with CD-ROM without storage

Packing List

Item	Part No.	Q'ty	Remark
Setting kit	46003-002600-RS	2	
Round head machine screw	44003-020041-RS	2	M2*4 round head machine screw
	44003-020041-RS	4	M2*4 round head machine screw
Pan head machine screw	44403-040061-RS	4	M4*6 pan head machine screw
Fix holder	46003-009500-RS	2	
Power cord	32702-000400-200-RS	1	
Power adapter	63040-010036-210-RS	1	36W; Vin: 90V~264V AC; Vout: 12VDC; Φ2.5/Φ5.5/lock
RJ-45 to DB-9 COM port transfer cable	32005-004600-100-RS (AFL3-08A)	1	300mm, 26AWG, (A) D-SUB 9 male, (B) RJ-45

AFL3-W07A
Fully Integrated I/O

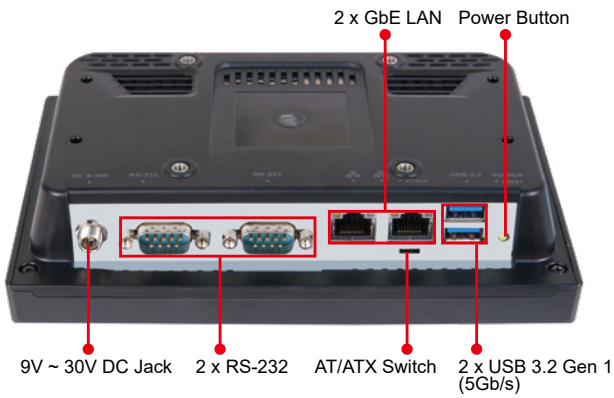

AFL3-08A
Fully Integrated I/O

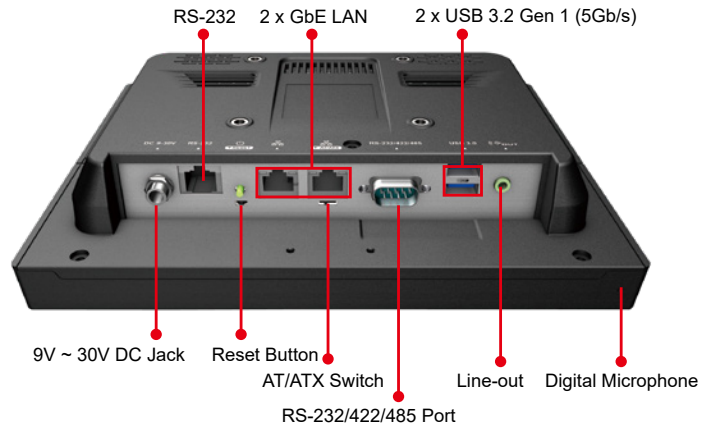

AFL3-W07A-BT Dimensions (Unit: mm)

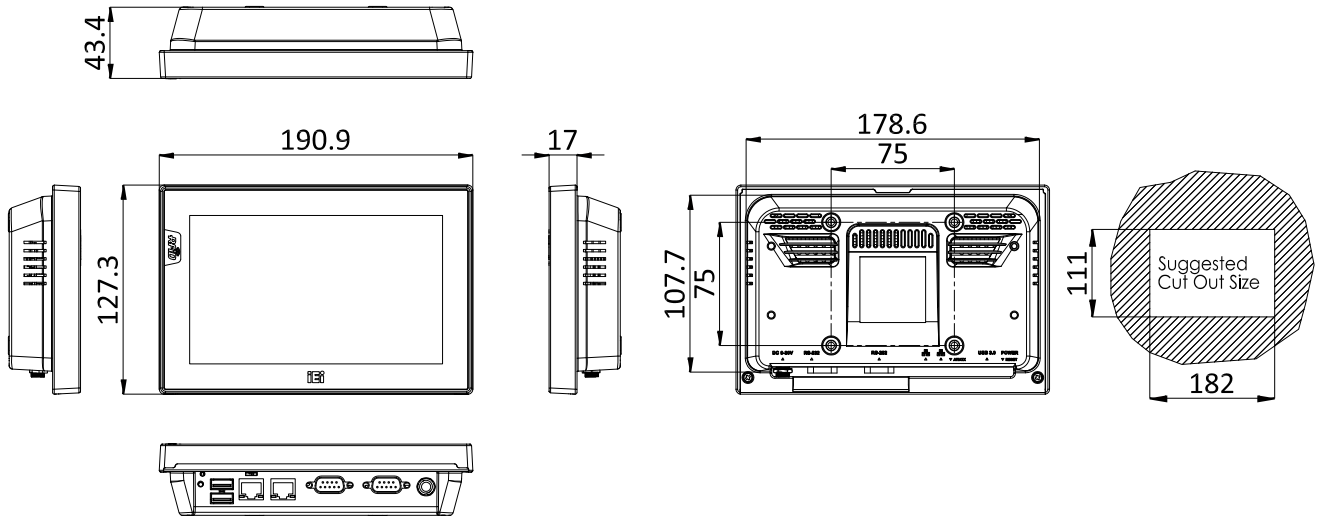

AFL3-08A-BT Dimensions (Unit: mm)

