

Neousys Technology Inc.
PB Standalone
SuperCap UPS Series

User Manual

Revision 1.6

Table of Contents

Table of Contents	2
Legal Information	4
Contact Information	5
Declaration of Conformity	5
Copyright Notice	6
Safety Precautions.....	7
Service and Maintenance	8
ESD Precautions	8
About This Manual	9
1 PB-9250J-SA/ PB-9250J-110V/ PB-4600J-SA/ PB-2580J-SA Overview	
1.1 Introduction	10
1.2 PB-9250J/PB-4600/PB-2580J-SA Series Specifications	11
1.3 PB-9250J-110V Specifications.....	12
1.4 Dimension	14
1.4.1 Main Panel View (Front View)	14
1.4.2 COM/ 10-Pin IO Panel View (Top View).....	15
2 Unpacking the System	
2.1 Packing List	16
2.2 Main Panel I/O.....	17
2.2.1 5A/ 10A Charging Current Switch	18
2.2.2 3-pin Terminal block and DC/ Ignition Input.....	19
2.2.3 Supercapacitor Energy Level	20
2.2.4 Charging/ Discharging Status LED	21
2.2.5 3-pin Terminal Block and DC/ Ignition Output	22
2.3 Side Panel I/O	23
2.3.1 COM Port.....	24
2.3.2 10-pin I/O Terminal Block	25
2.3.3 10-pin I/O Terminal Block (PB-9250J-110V).....	27
2.3.4 Reset Button	29
3 Mode Configuration	
3.1 Mode Connection	30
3.1.1 Normal Backup Mode	31
3.1.2 Ignition Control Mode.....	32
3.1.3 Ignition Relay Mode	33
3.2 Daisy Chain Connection (PB-9250J-SA Only).....	34
3.3 Configuring Windows System.....	35
4 CAP Energy Management Technology ~ Power Backup Parameter Configurer	
4.1 CAP Energy Management Technology	36
4.2 Power Backup Parameter Configurer	37
4.2.1 Executing Power Backup Parameter Configurer.....	37
4.2.2 Connecting to COM 1 Port on Host Computer	37
4.2.3 Connecting to a Different COM Port on Host Computer	38
4.2.4 Power Backup Parameter Configurer Overview.....	40
4.2.5 Behavior when Power Applied	42
4.2.6 Behavior when Power Loss	43
4.2.7 Shutdown at Low Voltage	44
4.2.8 Shutdown at High Voltage.....	45

Table of Content

4.2.9	SuperCAP Lifetime Extension.....	46
4.2.10	Operation Mode	47
4.2.11	IGN Setting	48
4.2.12	System Status Determined by.....	49
4.2.13	Update Parameters.....	50
4.2.14	Get Parameters.....	51
4.2.15	Load Default.....	51
4.2.16	Re-train	52
4.2.17	Reset	52
4.3	Estimated Extended Operation Time	53
4.4	PB-9250J-SA/ PB-9250J-110V Output Voltage Drop	54

Legal Information

All Neosys Technology Inc. products shall be subject to the latest Standard Warranty Policy

Neosys Technology Inc. may modify, update or upgrade the software, firmware or any accompanying user documentation without any prior notice. Neosys Technology Inc. will provide access to these new software, firmware or documentation releases from download sections of our website or through our service partners.

Before installing any software, applications or components provided by a third party, customer should ensure that they are compatible and interoperable with Neosys Technology Inc. product by checking in advance with Neosys Technology Inc.. Customer is solely responsible for ensuring the compatibility and interoperability of the third party's products. Customer is further solely responsible for ensuring its systems, software, and data are adequately backed up as a precaution against possible failures, alternation, or loss.

For questions in regards to hardware/ software compatibility, customers should contact Neosys Technology Inc. sales representative or technical support.

To the extent permitted by applicable laws, Neosys Technology Inc. shall NOT be responsible for any interoperability or compatibility issues that may arise when (1) products, software, or options not certified and supported; (2) configurations not certified and supported are used; (3) parts intended for one system is installed in another system of different make or model.

Contact Information

Headquarters
(Taipei, Taiwan) **Neosys Technology Inc.**
15F, No.868-3, Zhongzheng Rd., Zhonghe Dist., New Taipei City, 23586, Taiwan
Tel: +886-2-2223-6182 Fax: +886-2-2223-6183 [Email](#), [Website](#)

Americas
(Illinois, USA) **Neosys Technology America Inc.**
3384 Commercial Avenue, Northbrook, IL 60062, USA
Tel: +1-847-656-3298 [Email](#), [Website](#)

China **Neosys Technology (China) Ltd.**
Room 612, Building 32, Guiping Road 680, Shanghai
Tel: +86-2161155366 [Email](#), [Website](#)

Declaration of Conformity

FCC This equipment has been tested and found to comply with the limits for a Class A digital device, pursuant to part 15 of the FCC Rules. These limits are designed to provide reasonable protection against harmful interference when the equipment is operated in a commercial environment. This equipment generates, uses, and can radiate radio frequency energy and, if not installed and used in accordance with the instruction manual, may cause harmful interference to radio communications. Operation of this equipment in a residential area is likely to cause harmful interference in which case the user will be required to correct the interference at own expense.

CE The product(s) described in this manual complies with all applicable European Union (CE) directives if it has a CE marking. For computer systems to remain CE compliant, only CE-compliant parts may be used. Maintaining CE compliance also requires proper cable and cabling techniques.

Copyright Notice

All rights reserved. This publication may not be reproduced, transmitted, transcribed, stored in a retrieval system, or translated into any language or computer language, in any form or by any means, electronic, mechanical, magnetic, optical, chemical, manual or otherwise, without the prior written consent of Neosys Technology, Inc.

Disclaimer

This manual is intended to be used as an informative guide only and is subject to change without prior notice. It does not represent commitment from Neosys Technology Inc. Neosys Technology Inc. shall not be liable for any direct, indirect, special, incidental, or consequential damages arising from the use of the product or documentation, nor for any infringement on third party rights.

Patents and Trademarks

Neosys, the Neosys logo, Expansion Cassette, MezIO™ are registered patents and trademarks of Neosys Technology, Inc.

Windows is a registered trademark of Microsoft Corporation.

Intel®, Core™ are registered trademarks of Intel Corporation

NVIDIA®, GeForce® are registered trademarks of NVIDIA Corporation

All other names, brands, products or services are trademarks or registered trademarks of their respective owners.

Safety Precautions

- Read these instructions carefully before you install, operate, or transport the system.
- Install the system or DIN rail associated with, at a sturdy location
- Install the power socket outlet near the system where it is easily accessible
- Secure each system module(s) using its retaining screws
- Place power cords and other connection cables away from foot traffic. Do not place items over power cords and make sure they do not rest against data cables
- Shutdown, disconnect all cables from the system and ground yourself before touching internal modules
- Ensure that the correct power range is being used before powering the device
- Should a module fail, arrange for a replacement as soon as possible to minimize down-time
- If the system is not going to be used for a long time, disconnect it from mains (power socket) to avoid transient over-voltage

Service and Maintenance

- ONLY qualified personnel should service the system
- Shutdown the system, disconnect the power cord and all other connections before servicing the system
- When replacing/ installing additional components (expansion card, memory module, etc.), insert them as gently as possible while assuring proper connector engagement

ESD Precautions

- Handle add-on module, motherboard by their retention screws or the module's frame/ heat sink. Avoid touching the PCB circuit board or add-on module connector pins
- Use a grounded wrist strap and an anti-static work pad to discharge static electricity when installing or maintaining the system
- Avoid dust, debris, carpets, plastic, vinyl and styrofoam in your work area.
- Do not remove any module or component from its anti-static bag before installation

About This Manual

This manual introduces and demonstrates installation procedures of Neousys intelligent ultracapacitor-based power backup standalone module, PB-9250J-SA, PB-9250J-110V, PB-4600J-SA and PB-2580J-SA.

Revision History

Version	Date	Description
1.0	May. 2019	Initial release
1.1	Jul. 2019	Updated SuperCap operation lifespan data in “SuperCap Lifetime Extension” setting
1.2	Aug. 2019	Added PB-4600J-SA
1.3	Dec. 2020	Backend constant voltage notice *** under specifications
1.4	Mar. 2021	Updated “Update Parameters”
1.5	Sep. 2021	Added PB-2580J-SA
1.6	Jul. 2023	User manual renamed to “PB Standalone SuperCap UPS Series” Added PB-9250J-110V

1 PB-9250J-SA/ PB-9250J-110V/ PB-4600J-SA/ PB-2580J-SA Overview

1.1 Introduction

PB-9250J-SA, PB-9250J-110V, PB-4600J-SA and PB-2580J-SA are standalone power backup modules that can protect your box-PC against power outages. Utilizing state-of-the-art supercapacitor technology, they can operate in harsh environments from -25 to 65°C, while the PB-9250J-110V accepts 110V for fast-growing railway applications. The supercapacitors feature extremely high durability lasting over 10 years and the PB-9250J/4600J series are composed of eight/ four 370F/ 3.0V supercapacitors respectively and the PB-2580J is composed of eight 100F/ 2.7V supercapacitors. They each store 9250/ 4600/ 2500 watt-second energy to offer extra extended operation time to backup your system.

Thanks to Neosys' patented CAP energy management technology, it can reliably supply up to 180W power to the back-end system and automatically manage boot and shutdown without installing additional drivers/ software. In addition to UPS-like power backup mode, it also offers two advanced ignition control modes for working with either standard box-PC or in-vehicle controller to provide stable power supply and execute user-configurable power-on/ power-off delay according to IGN signal input.

Featuring various modes, automatic shutdown control and up to 180W output power, Neosys standalone power backup modules can work with most off-the-shelf box-PCs. And with properties such as maintenance-free energy storage and uninterruptible power supply, they can prevent data loss for the connected back-end system during power outages in harsh industrial environments!



PB-9250J-SA/ PB-4600J-SA



PB-9250J-110V



PB-2580J-SA

1.2 PB-9250J/PB-4600/PB-2580J-SA Series Specifications

Supercapacitor Configuration			
	PB-9250J-SA	PB-4600J-SA	PB-2580J-SA
Composition	8x 370F, 3.0Vsupercapacitors	4x 370F, 3.0Vsupercapacitors	8x 100F, 2.7Vsupercapacitors
Capacity	9250 watt-second	4600 watt-second	2500 watt-second
Expected lifespan	>10 years*		
Cycle life	500,000 charging/discharging cycles*		
Power Specification			
Input Voltage	12~35 VDC		
Input Connector	1x 3-pin pluggable terminal block (V+, GND, IGN_IN)		
Output Voltage	Charge mode: DC_IN bypass (DC_OUT = DC_IN) Discharge mode: 12 or 24V ***		
Output Power	Maximum 180W output**	Maximum 100W output**	Maximum 70W Output**
Output Connector	1x 3-pin pluggable terminal block (V+, GND, IGN_OUT)		
I/O Interface			
COM Port	1x DB9 for 3-wire RS-232		
Isolated DIO	1x 10-pin pluggable terminal block for		
Mechanical and Environmental			
Dimension	82.5mm(W) x 175.2mm(H) x 128.2mm(D)		32.8mm(W) x 176.6mm(H) x 126mm(D)
Weight	1.70 Kg	1.68 Kg	0.93 Kg
Mounting	DIN-rail mounting or optional wall-mounting		
Operating Temperature	-25°C ~ 65°C		
Storage Temperature	-40°C ~ 85°C		
Vibration	IEC61373:2010, Category 1, Class B Body mounted (part of EN50155)		
Shock	IEC61373:2010, Category 1, Class B Body mounted (part of EN50155)		
Certification	EN50155:2007,		

* To achieve > 10 years lifespan under 24/7 at 65°C operation, please charge PB-9250J-SA to 6525J/PB-4600J-SA to 3245Jenergy level using the [4.8x SuperCAP Lifetime Extension setting](#). Once the rated lifetime or cycle life has been reached, the capacity of supercapacitor may decrease up to 30% and ESR may increase up to 100% from initial values.

** Backup time for uninterruptible operation may be reduced when sustaining a back-end system with high power consumption.

*** To ensure PB standalone module's power backup operation functions as intended, please contact Neousys Technology technical support if your connecting back-end system accepts only constant voltage input.

1.3 PB-9250J-110V Specifications

Supercapacitor Configuration	
	PB-9250J-110V
Composition	8x 370F, 3.0V supercapacitors
Capacity	9250 watt-second
Expected lifespan	>10 years*
Cycle life	500,000 charging/discharging cycles*
Power Specification	
Input Voltage	43-160 VDC
Input Connector	1x 3-pin pluggable terminal block (V+, GND)
Output Voltage	24 VDC***
Output Power	Maximum 120W**
Output Connector	1x 3-pin pluggable terminal block (V+, GND)
I/O Interface	
COM Port	1x DB9 for 3-wire RS-232
Isolated DIO	1x 10-pin pluggable terminal block for - PWR_BTN# output/ SYS_STAT input
Mechanical	
Dimension	110(W) x 175.2mm(H) x 128.2mm(D)
Weight	2.33 Kg
Mounting	DIN-rail mounting or optional wall-mounting
Environmental	
Operating Temperature	-40°C to 65°C EN50155 OT4 Class -40°C to 85°C with reduced energy capacity
Storage Temperature	-40°C to 85°C
Vibration	IEC61373:2010, Category 1, Class B Body mounted (part of EN50155)
Shock	IEC61373:2010, Category 1, Class B Body mounted (part of EN50155)
EMC	EN 50155:2017, Clause 13.4.8 CE/FCC Class A, according to EN55032 & EN55035 CE/FCC Class A, according to EN 55032 & EN 55035
EN50155	All mandatory section of EN50155:2017
EN45545	EN45545-2 (Fire protection on railway vehicles)

* To achieve > 10 years lifespan under 24/7 at 65°C operation, please charge PB-9250J-110V to 3245Jenergy level using the [4.8x SuperCAP Lifetime Extension setting](#). Once the rated lifetime or cycle life has been reached, the capacity of supercapacitor may decrease up to 30% and ESR may increase up to 100% from initial values.

** Backup time for uninterruptible operation may be reduced when sustaining a back-end system with

high power consumption.

**** To ensure PB standalone module's power backup operation functions as intended, please contact Neosys Technology technical support if your connecting back-end system accepts only constant voltage input.*

1.4 Dimension

 **NOTE**
All measurements are in millimeters (mm).

1.4.1 Main Panel View (Front View)

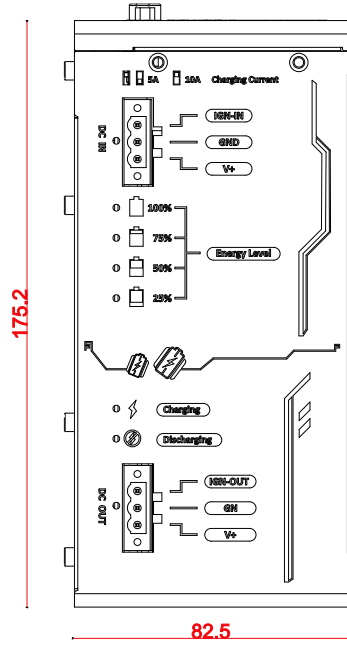

PB-9250J-SA/ PB-4600J-SA

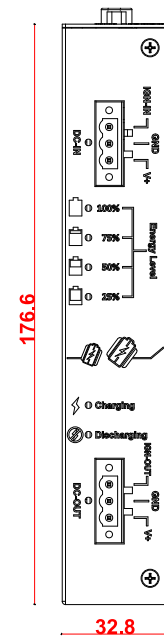

PB-2580J-SA

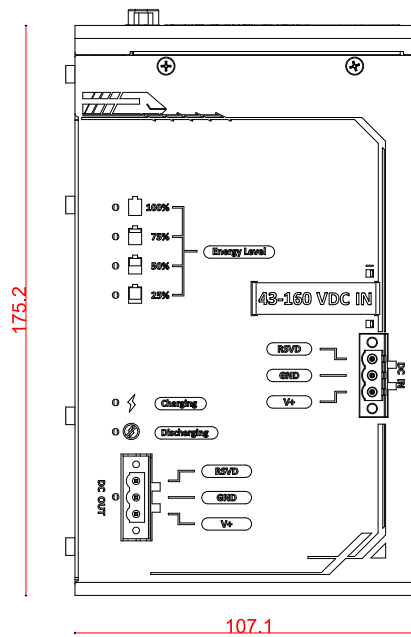

PB-9250J-110V

1.4.2 COM/ 10-Pin IO Panel View (Top View)

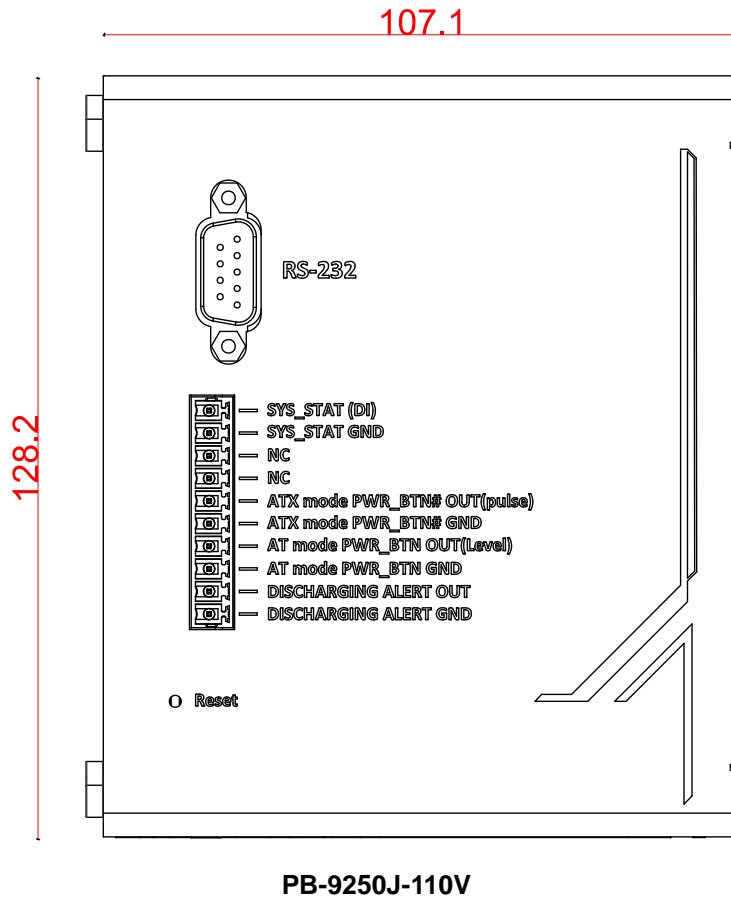
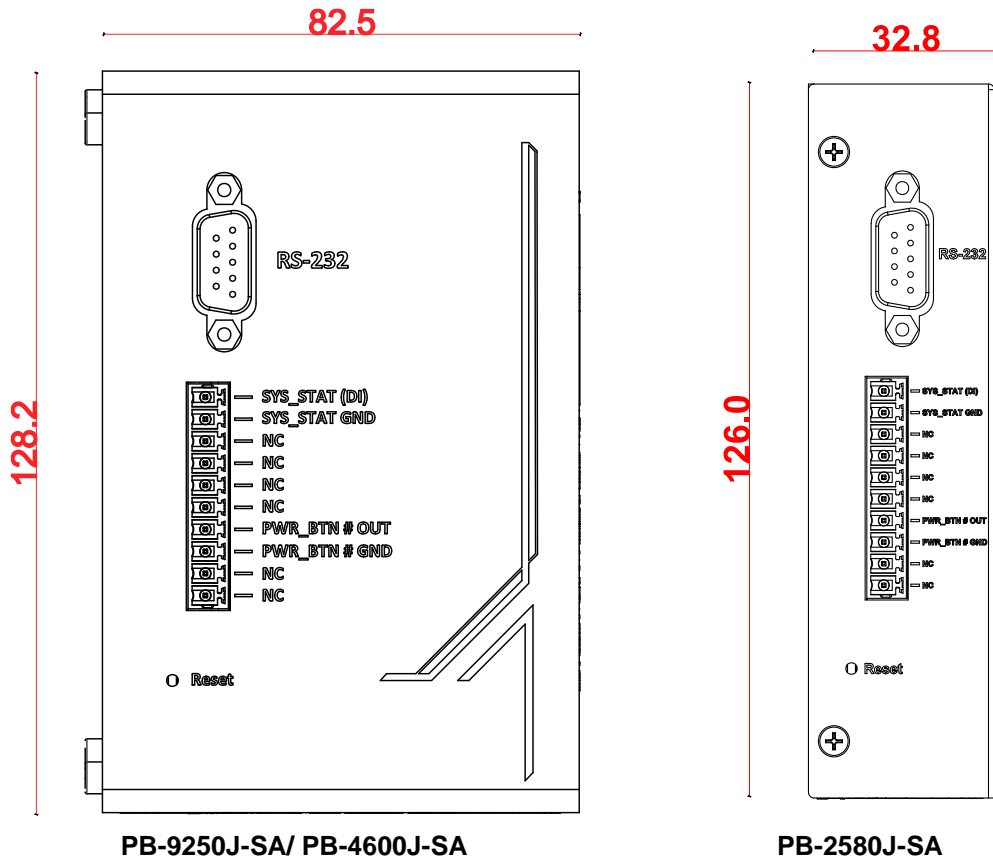

2 Unpacking the System

Upon receiving and unpacking your PB standalone module, please check immediately if the package contains all the items listed in the following table. If any item(s) are missing or damaged, please contact your local dealer or Neosys Technology.

2.1 Packing List

Item	Description	Qty
1	PB-9250J-SA/ PB-9250J-110V/ PB-4600J-SA/ PB-2580J-SA	1
2	3-pin power terminal block	2
3	10-pin I/O terminal block	1
4	DIN-rail clip set (standard)/ wall-mount bracket (optional)	1
5	DB9 (Female) to DB9 (Female) cable	1

2.2 Main Panel I/O

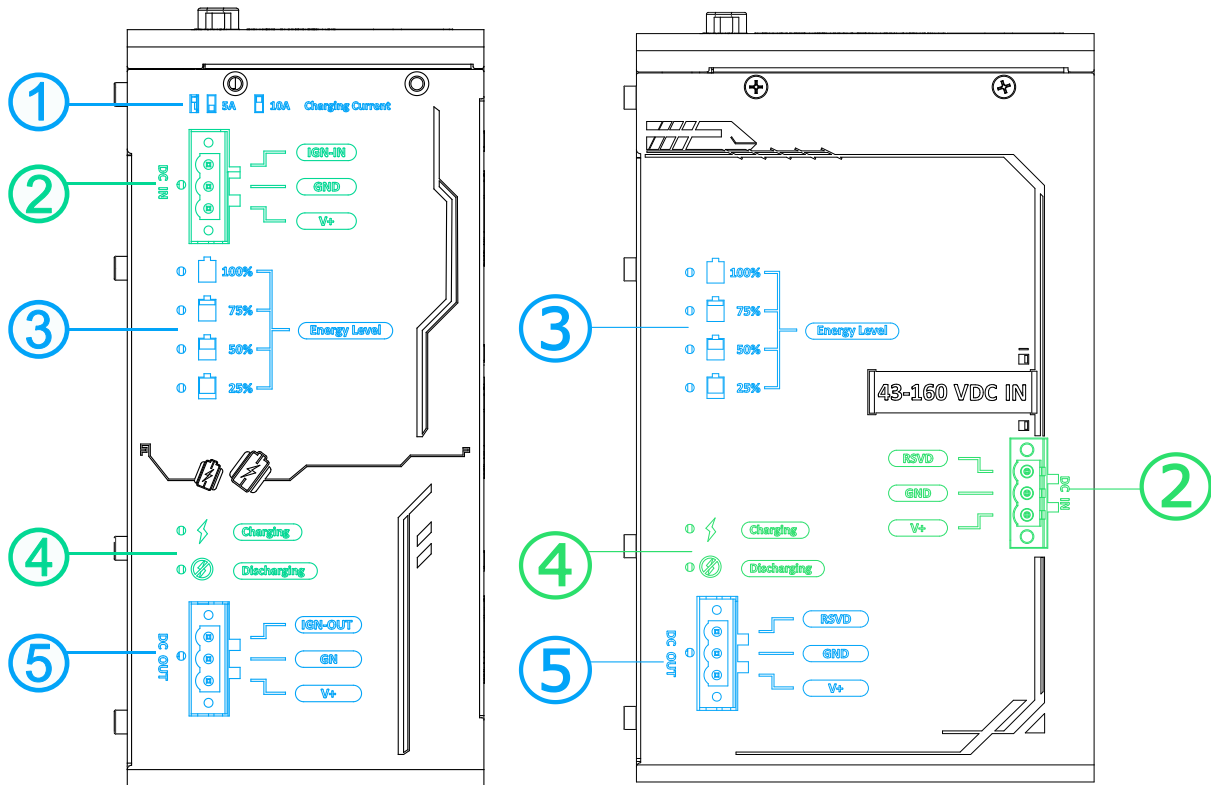

PB-9250/4600/2580

PB-9250J-110V

No.	Item	Description
1	Charging current switch	Charging current selector switch for 5A or 10A . *Not applicable to PB-2580J-SA
2	3-pin terminal block	12-35V models: Compatible with DC power input from 12 to 35V, the terminal block is also used for ignition signal input. 43-160V models: Compatible with voltage input from 43 to 160V
3	Battery capacity LED	Indicates capacity level at or less than 100 / 75 / 50 / 25 percent.
4	Charging / discharging status LED	LED status indicating if the module is being charged or in a discharge status.
5	3-pin terminal block for DC/ignition output	12-35V models: Has an output voltage of 12 to 24V, and the terminal block is also used for ignition signal input. 43-160V models: Has an output voltage of 24V

2.2.1 5A/ 10A Charging Current Switch

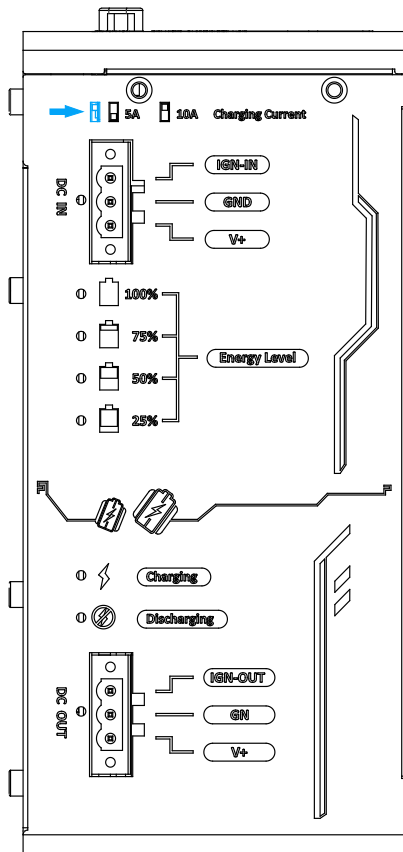

PB-9250J/ 4600J can be set to charge at 5A or 10A input. The different current input will result in different charging times from 0% to full. Please refer to the following table:

	Current	Voltage	Approx. charging time (from 0%)
PB-9250J	5A	24V	100 seconds
		12V	185 seconds
	10A	24V	50 seconds
		12V	75 seconds
	Current	Voltage	Approx. charging time (from 0%)
PB-4600J	5A	24V	45 seconds
		12V	90 seconds
	10A	24V	25 seconds
		12V	35 seconds



NOTE

The power adapter must supply 6A or more for 5A charging.

The power adapter must supply 13A or more for 10A charging.

For PB-9250-J-110V, the power supply must provide at least 6A to charge the capacitors. It takes approximately 100 seconds for PB-9250J-110V to fully charged.

2.2.2 3-pin Terminal block and DC/ Ignition Input

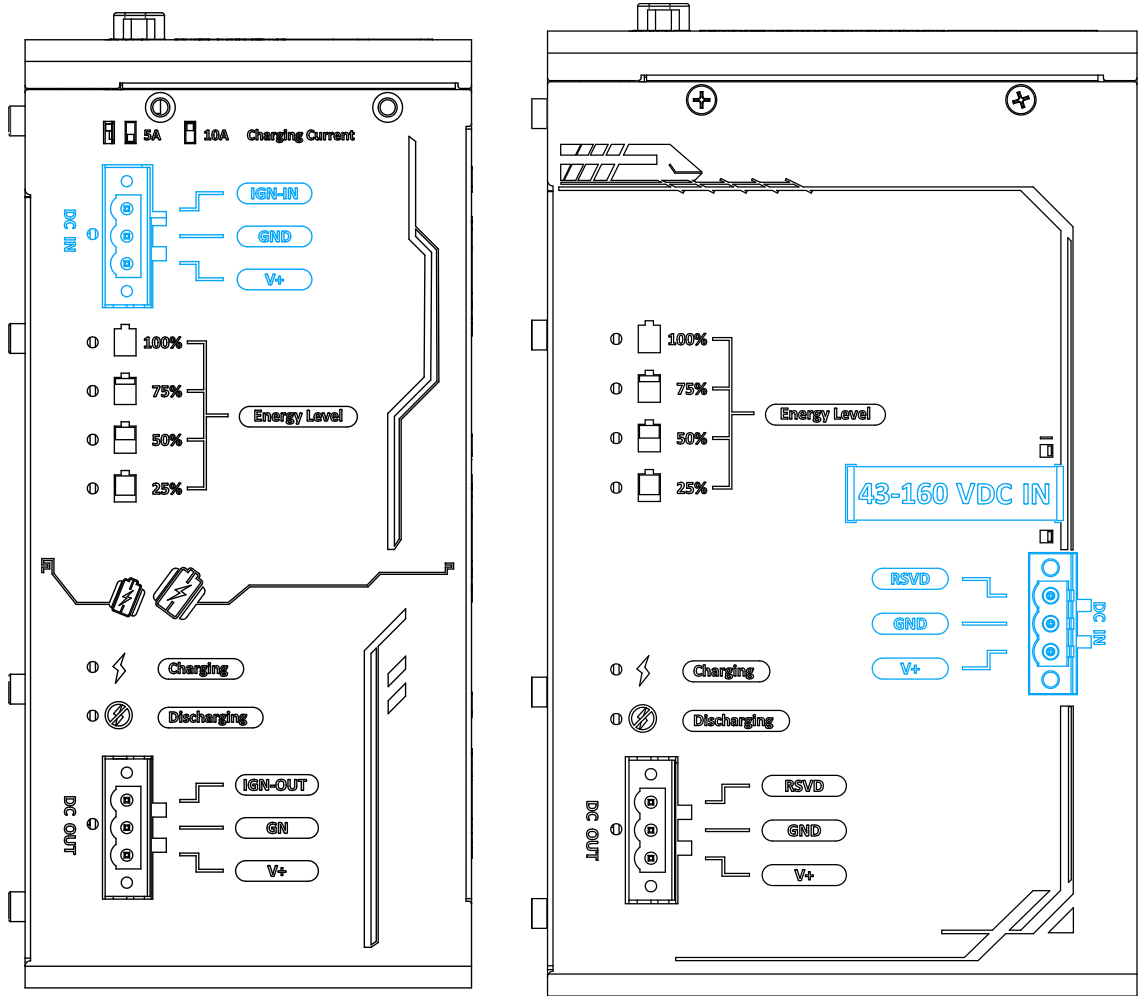

PB-9250/4600/2580

PB-9250J-110V

The module accepts a wide range of DC power input from 12 to 35V or 43 to 160V via a 3-pin pluggable terminal block. The screw clamping mechanism on the terminal block offers connection reliability when wiring power. For 12 to 35V models, this terminal block can also accept ignition signal input (IGN) when PB standalone module is configured in Ignition Control Mode/ Ignition Relay Mode for in-vehicle applications.

2.2.3 Supercapacitor Energy Level

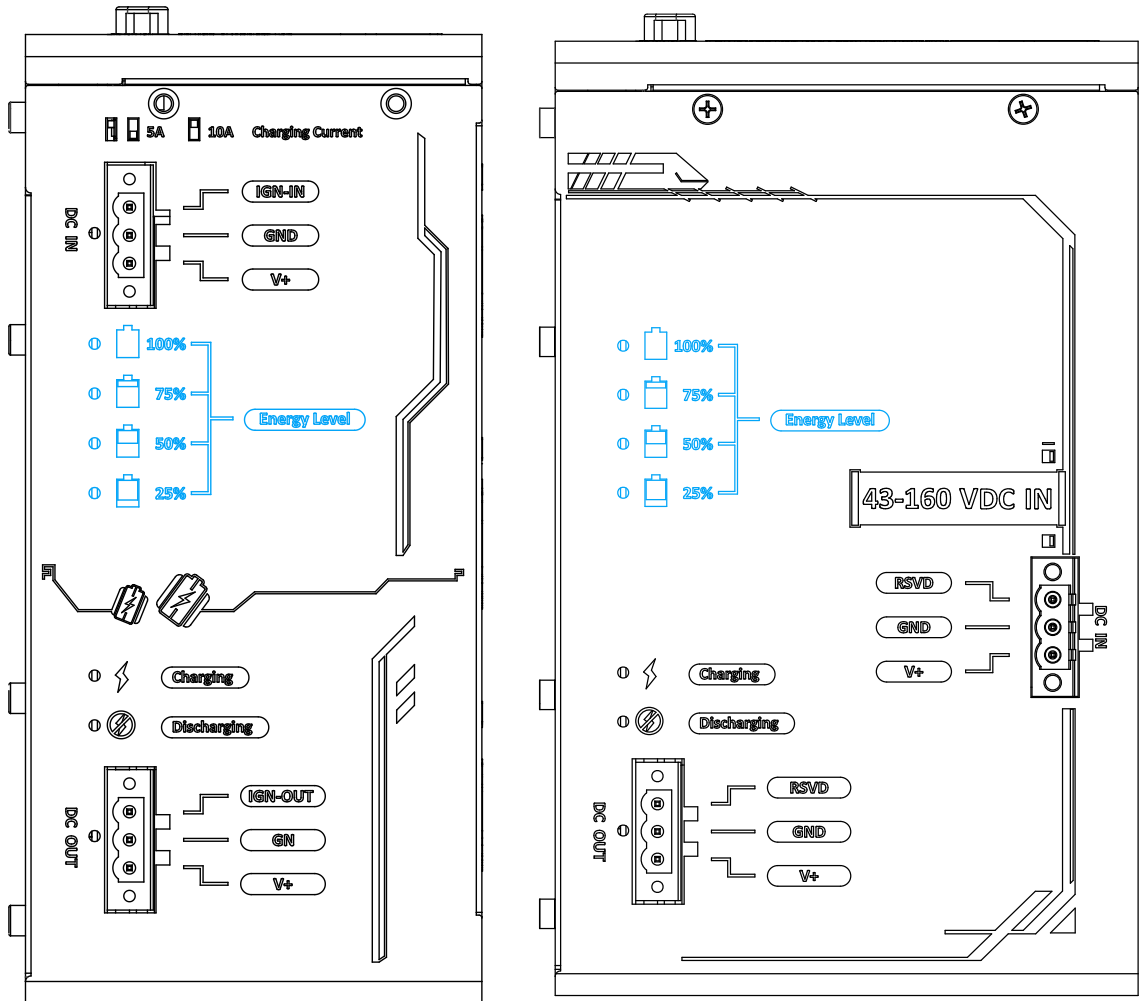

PB-9250/4600/2580

PB-9250J-110V

LED	Color	Status	Description
100%	Green	Steady-lid	Energy of the SuperCAP reached 100%
		Off	Energy of the SuperCAP is below 100%
75%	Green	Steady-lid	Energy of the SuperCAP reached 75%
		Off	Energy of the SuperCAP is below 75%
50%	Green	Steady-lid	Energy of the SuperCAP reached 50%
		Off	Energy of the SuperCAP is below 50%
25%	Green	Steady-lid	Energy of the SuperCAP reached 25%
		Off	Energy of the SuperCAP is below 25%

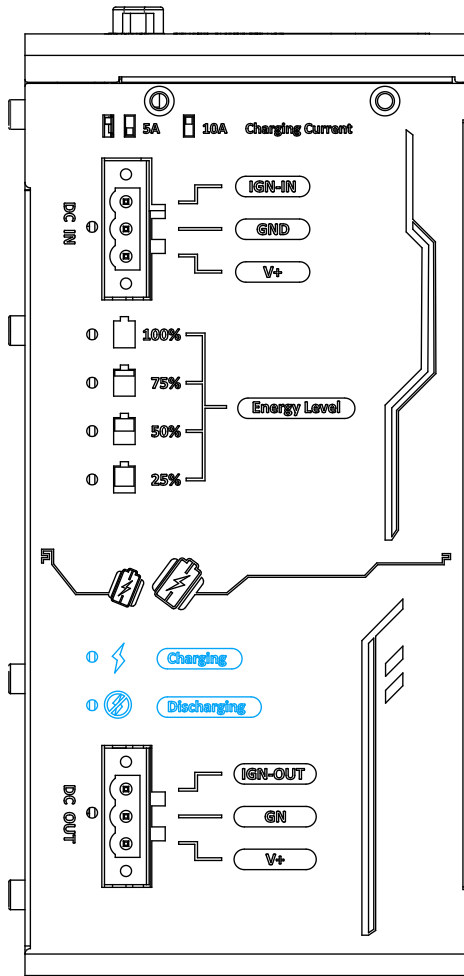

2.2.4 Charging/ Discharging Status LED

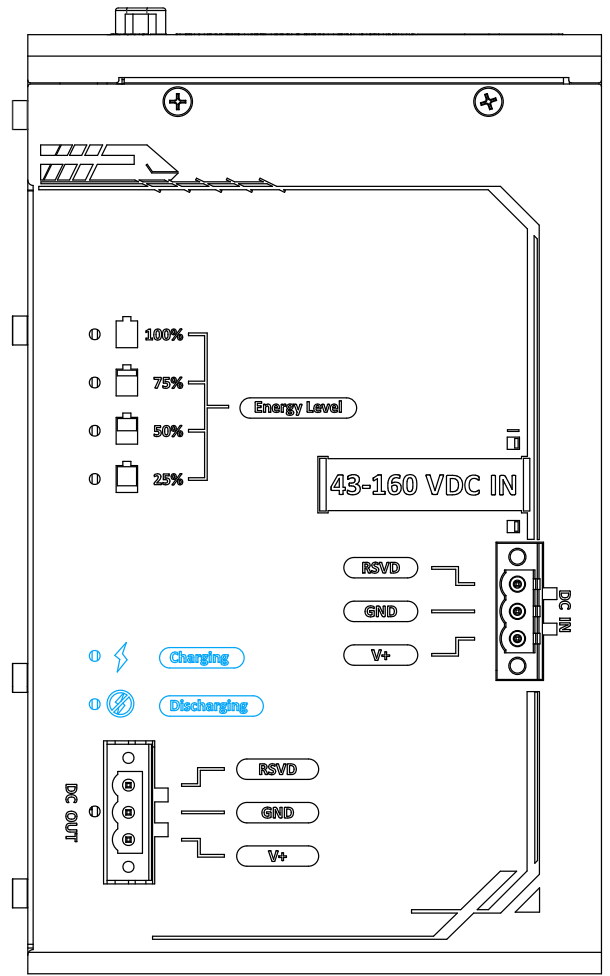

PB-9250/4600/2580



PB-9250J-110V

LED	Color	Status Description
	Orange	When lit, it indicates PB standalone module is being charged.
	Red	When flashing, it indicates a discharge status.

2.2.5 3-pin Terminal Block and DC/ Ignition Output

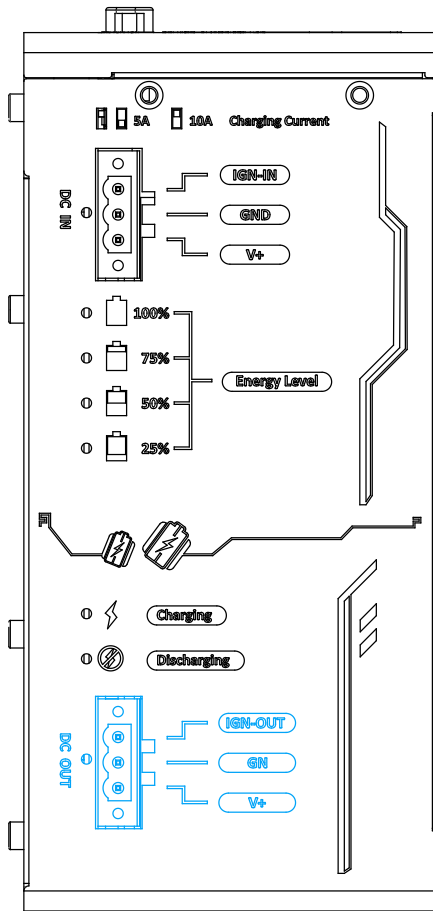

PB-9250/4600/2580

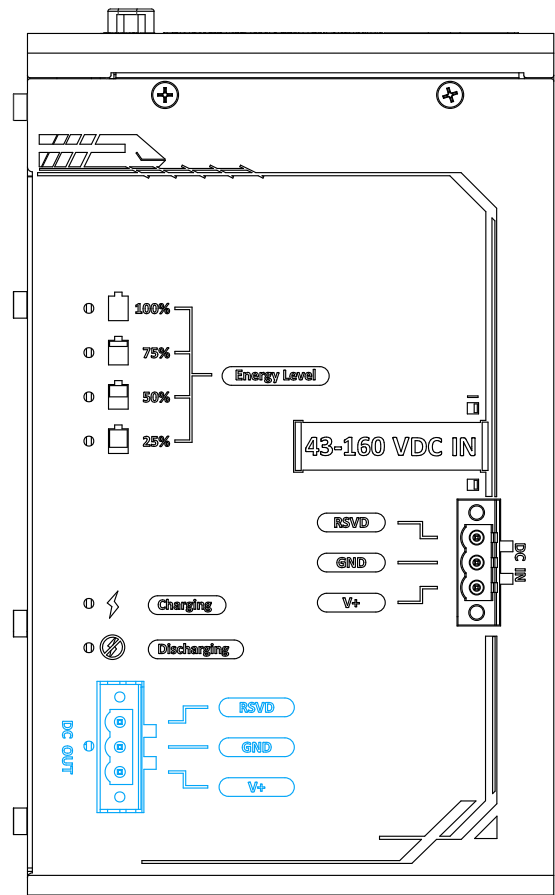

PB-9250J-110V

When discharging, the system provides 12V-24V DC or power output via a 3-pin pluggable terminal block. The screw clamping mechanism on the terminal block offers connection reliability when wiring DC power. In addition to DC power output, this terminal block can also send ignition signal output (IGN) to back-end system when PB standalone module is configured in Ignition Control Mode/ Ignition Relay Mode for in-vehicle applications.

 **NOTE**

If the input voltage is equal or higher than 17V, the output voltage during the discharge status will be 24V.

If the input voltage is lower than 17V, the output voltage during the discharge status will be 12V.

2.3 Side Panel I/O

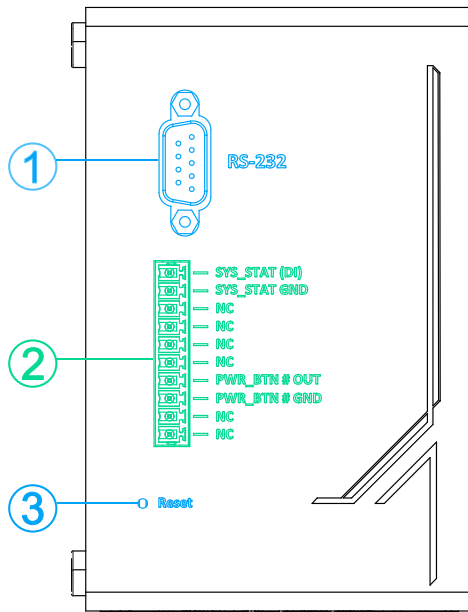

PB-9250/4600/2580

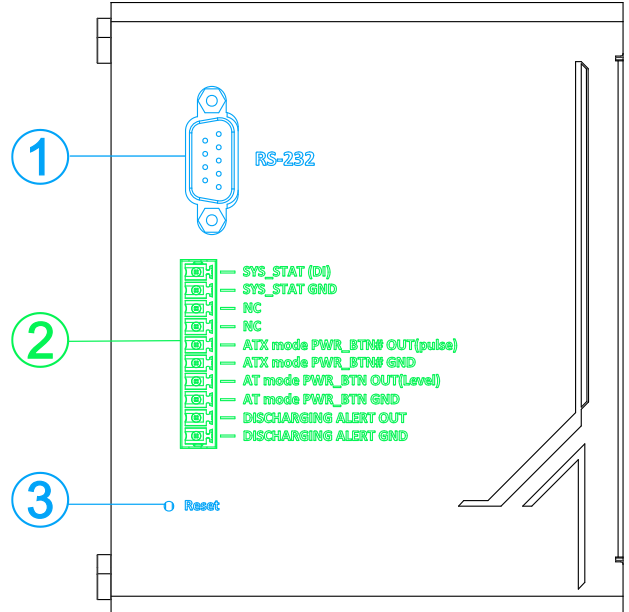

PB-9250J-110V

No.	Item	Description
1	RS-232 COM port	9-pin D-sub COM port to connect to the host computer.
2	10-pin I/O terminal block	10-pin input/ output terminal block consists of two signal pairs: power button signal output and system status input. For PB-9250J-110V , it also includes ATX/ AT mode signals.
3	Reset button	The button is for users to manually reset and load system default configuration in case of a system halt or malfunction.

2.3.1 COM Port

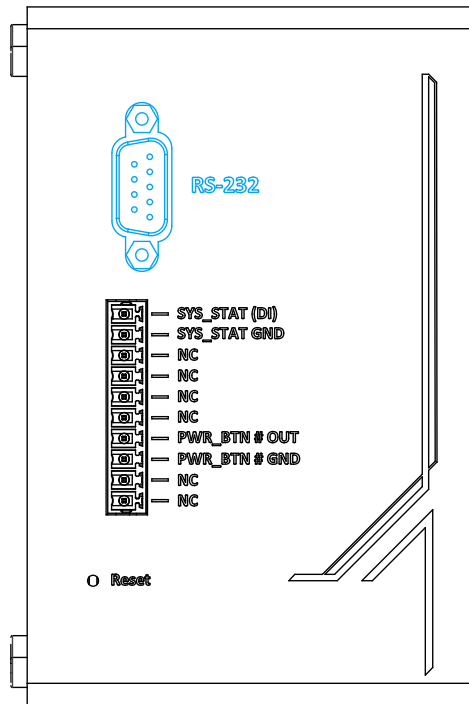

PB-9250/4600/2580

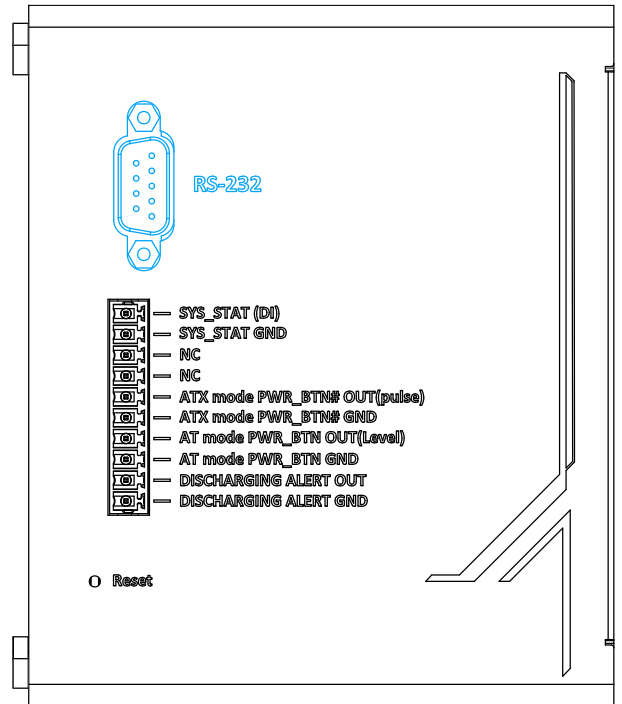

PB-9250J-110V

The 9-pin D-sub COM port can connect and communicate with the host computer to acquire PB standalone module's information.

 **NOTE**

The host computer's COM port must be configured in RS-232 mode to properly communicate with PB standalone module.

2.3.2 10-pin I/O Terminal Block

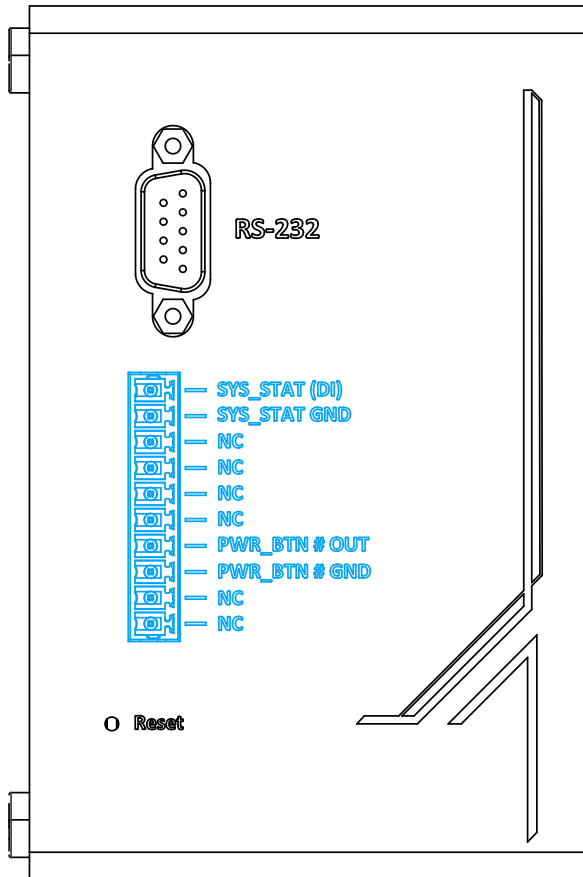

There are two signal pairs on the 10-pin I/O terminal block. One is system status input (SYS_STAT), the other is power button signal output (PWRBTN#).

SYS_STAT

The systems status input (SYS_STAT) signal pair is optional due to PB standalone module's built-in status detection function which can automatically detect the back-end system status via the power consumption of the system.

System status signal pair is used to detect the status of the back-end system (whether it is running or turned off). This signal pair is optional due to PB standalone module's built-in status detection function which can automatically detect the back-end system status via the power consumption of the system.

PWR_BTN#

Power button signal pair is sent by PB standalone module to turn on/off the back-end system. It should be connected to the remote control signal pair on the back-end system. The PWRBTN# signal pair is an open/ short signal. It is necessary to link the PWRBTN# signal pair in order for boot/ shutdown control.

Note that the signal input pair of PB standalone module can accept 5~24V voltage output from back-end system to indicate the status (on/ off) of the system, for example the USB 5V of general box-PC. Also, digital input signal should be high when the back-end system is on, and

low when system is off

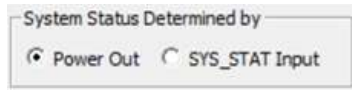

NOTE

PB standalone module should be configured to SYS_STAT Input via utility when user decides to connect system status signal pair.

2.3.3 10-pin I/O Terminal Block (PB-9250J-110V)

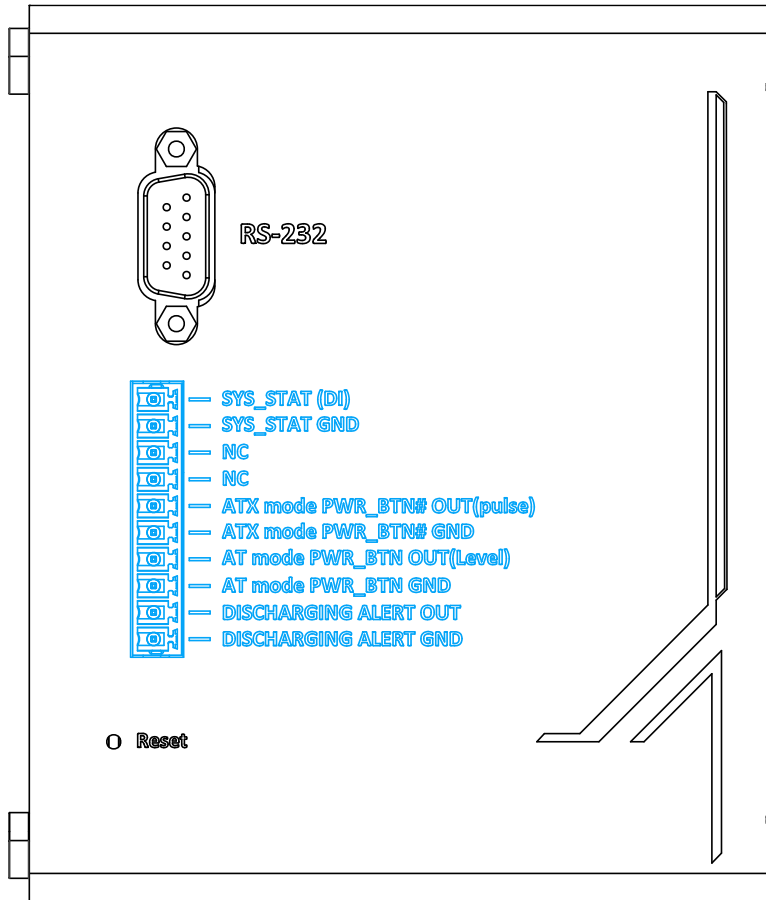

SYS_STAT

The systems status input (SYS_STAT) signal pair is optional due to PB standalone module's built-in status detection function which can automatically detect the back-end system status via the power consumption of the system.

ATX mode PWR_BTN#

ATX mode PWR_BTN# signal pair is sent by PB standalone module to turn on/off the back-end system. ATX mode PWRBTN# signal pair is an open/ short signal. If the back-end system is ATX mode, please connect the remote control signal pair on the back-end system to ATX mode PWR_BTN# signal pair on PB.

AT mode PWR_BTN#

AT mode PWR_BTN# signal pair is sent by PB standalone module to turn on/off the back-end system. AT mode PWRBTN# signal pair is an open/ short signal. The signal pair will be short-circuited when the PB is about to turn on the backend, and open-circuited while PB is about to turn off the system. If the back-end system is AT mode, please connect the remote control signal pair on the back-end system to AT mode PWR_BTN# signal pair on PB.

**NOTE**

It is necessary to connect either ATX mode PWR_BTN# signal pair or AT mode PWR_BTN# signal pair to the remote control signal pair on the back-end system in order for boot/shutdown control.

DISCHARGING ALERT

DISCHARGING ALERT signal pair is sent by PB standalone module to notify if PB is discharging. DISCHARGING ALERT signal pair is an open/ short signal(open drain). The signal pair will be short-circuited when the PB is discharging, and open-circuited while PB is charging

**NOTE**

Please note that DISCHARGING ALERT signal pair does not have internal pull high, and the OC limitation is 500mA.

2.3.4 Reset Button

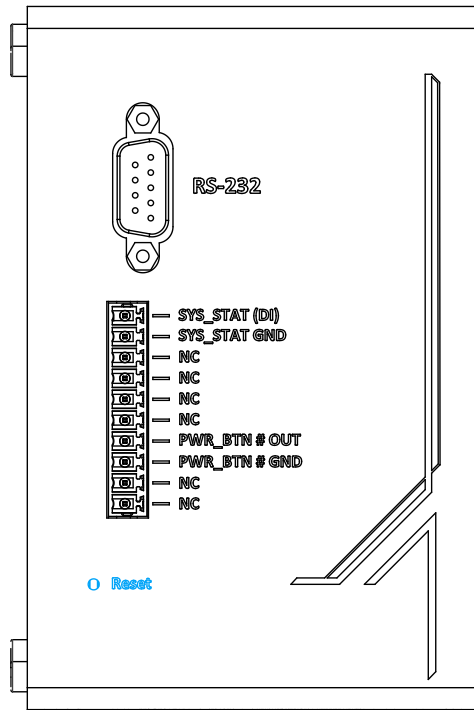

PB-9250/4600/2580

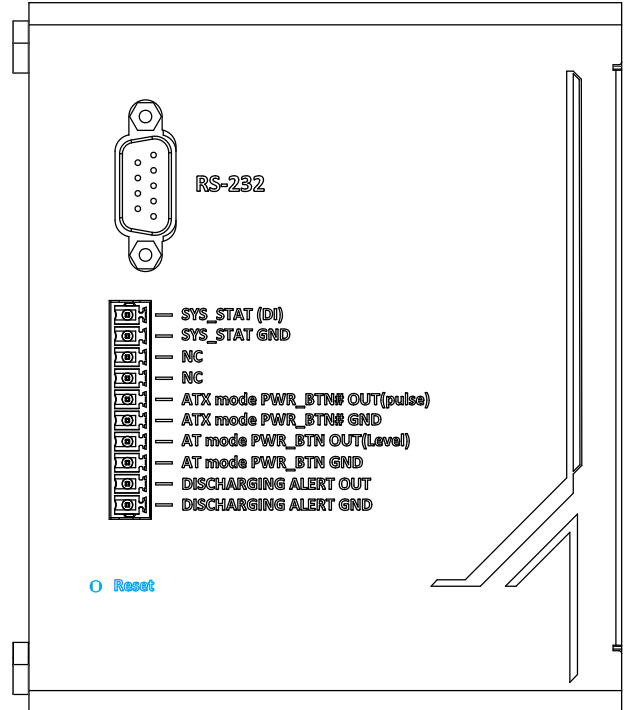

PB-9250J-110V

The reset button is used to manually reset and load system default configuration in case of a system halt or malfunction. To avoid unexpected operation, the button is purposely placed behind the panel. To reset the system, please use a pin to poke the button behind the panel for 5 seconds till one long beep is heard.

3 Mode Configuration

3.1 Mode Connection

Depending on your PB standalone module, it can be configured to three different operating modes: Normal Backup Mode/ Ignition Control Mode/ Ignition Relay Mode. The following sections show detail information about how to connect and use the three different modes.

PB Module and Supported Modes:

	Normal Backup Mode	Ignition Control Mode	Ignition Relay Mode	Daisy Chain
PB-9250J-SA	○	○	○	○
PB-4600J-SA	○	○	○	X
PB-2580J-SA	○	○	○	X
PB-9250J-110V	○	X	X	X

Normal Backup Mode

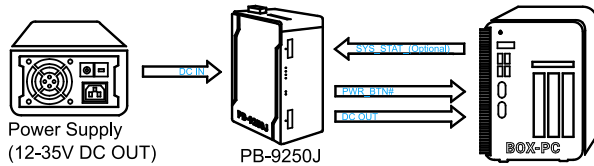

Ignition Control Mode

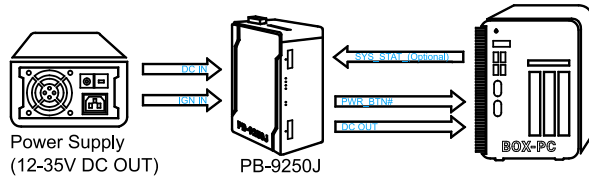

Ignition Relay Mode

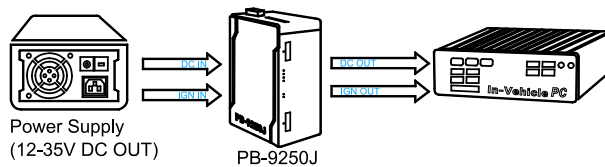

3.1.1 Normal Backup Mode

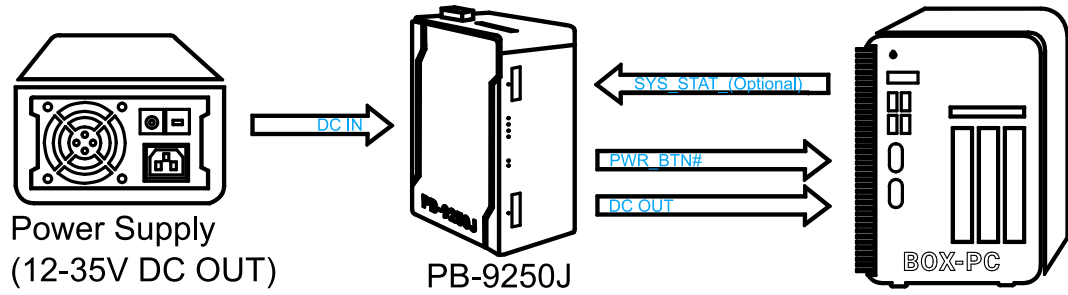

Normal Backup Mode is for general purpose use of PB standalone module. In Normal Backup Mode, DC output from power supply should be connected to the DC IN of PB standalone module. DC OUT of PB standalone module should be connected to the power input of the back-end system. In addition, user should connect PWRBTN# signal pairs to the remote control or whichever connector that is connected to the power button signal of the back-end system.

In Normal Backup Mode, PB standalone module begins to charge as soon as the power is supplied. Charging time may take up to a few minutes to fully charge PB standalone module (depending on charging current and input voltage). Afterwards, PB standalone module will automatically initiate the power button signal to turn on the back-end system. Under power blackout condition, PB standalone module can sustain back-end system operation by supplying 12V/24V power output. The PB standalone module can calculate the energy it needs for back-end system to properly turn off. In other words, PB standalone module can sustain the connected system as long as possible before initiating a power button signal to shut down the system.

 **NOTE**

If the input voltage is equal or higher than 17V, the output voltage during the discharge status will be 24V.

If the input voltage is lower than 17V, the output voltage during the discharge status will be 12V.

3.1.2 Ignition Control Mode

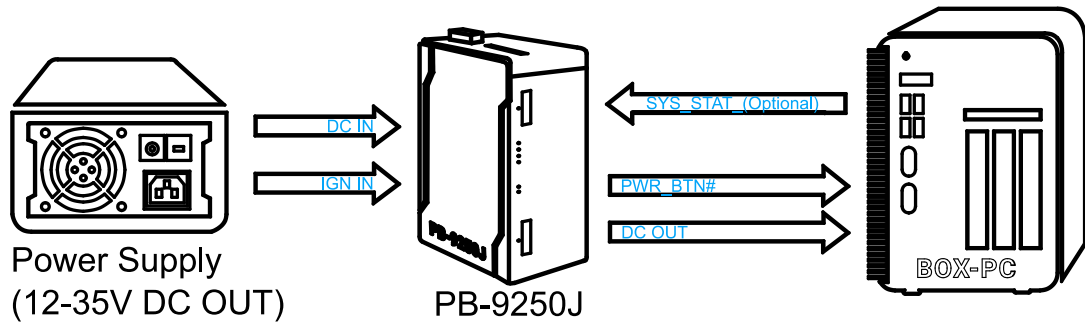

Ignition Control Mode is ideal for box-PCs that lack the ignition control function, but still need and want to operate as an in-vehicle controller. With PB standalone module's built-in IGN control function, the PB standalone module receives the IGN signal and sends a power button signal to the connected system. In Ignition Control Mode, DC output from power supply should be connected to the DC IN of PB standalone module. IGN input should also be connected to IGN IN of PB standalone module (same connector of power input). DC OUT of the PB standalone module should be connected to the power input of the back-end system. In addition, user should connect PWRBTN# signal pairs to the remote control or whichever connector is connected to the power button signal of the back-end system.

Once the system has been connected to power input and IGN signal, PB standalone module will begin to charge once the user-defined on-delay period has been set. It may take up to a few minutes to fully charge PB standalone module (depending on charging current and input voltage). Afterwards, the PB standalone module will automatically initiate the power button signal to turn on the back-end system. When the system is in operation, the PB standalone module will turn off the connected system according to the user-defined delay time if IGN input is turned off. Under power blackout condition, the PB standalone module can sustain back-end system operation by supplying 12V/24V power output as the same as Normal Backup Mode. The PB standalone module can sustain the connected system as long as possible and then initiate the power button signal before shutting down the system. If power input and IGN is turned off simultaneously, the PB standalone module will shutdown the system according to the user-defined IGN off delay time if the IGN off delay is shorter than the estimated learnt time for shutting down the system, and vice versa.



NOTE

If the input voltage is equal or higher than 17V, the output voltage during the discharge status will be 24V.

If the input voltage is lower than 17V, the output voltage during the discharge status will be 12V.

3.1.3 Ignition Relay Mode

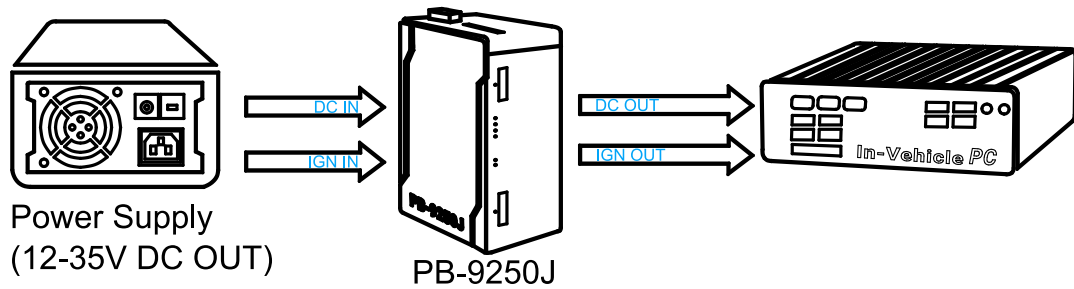

Ignition Relay Mode is for in-vehicle box-PCs in transportation application. In Ignition Relay Mode, the PB standalone module can receive IGN input signal and pass it to the back-end system. DC output from power supply should be connected to the DC IN of the PB standalone module. IGN input should also be connected to IGN IN of the PB standalone module. DC OUT of the PB standalone module should be connected to the power input of the back-end system. In addition, IGN OUT of the PB standalone module should be connected to the IGN input of the back-end system.

Once the system has been setup, the PB standalone module will begin to charge when power input and IGN are both supplied. It may take up to a few minutes to fully charge the PB standalone module (depending on charging current and input voltage). Afterwards, the PB standalone module will automatically initiate IGN signal in order to turn on the back-end system. During system operation, the PB standalone module will cut off IGN signal if the IGN input is turned off. Under power blackout condition, the PB standalone module can sustain back-end system operation by supplying 12V/24V power output, but note that the PB standalone module can only cut off the IGN out signal if IGN input of the PB standalone module is turned off. In other words, PB standalone module's role is to only relay IGN signal in real-time and the IGN on/off delay depends on the back-end system.



NOTE

If the input voltage is equal or higher than 17V, the output voltage during the discharge status will be 24V.

If the input voltage is lower than 17V, the output voltage during the discharge status will be 12V.

3.2 Daisy Chain Connection (PB-9250J-SA Only)

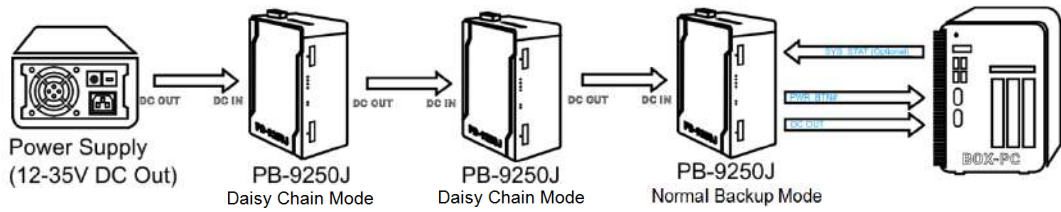

Daisy chain connection is only applicable to PB-9250J. PB-9250J can be wired together in sequence to extend energy capacity. To daisy chain PB-9250Js, user should connect DC power input into the first PB-9250J. Then connect the power output to next power input of PB-9250J, and so on. The power output of the last PB-9250J which is nearest to the system should connect to the power input of the backend system. Remember to connect power button and remaining signal to the system. Please refer to the example shown above with three PB-9250Js daisy chained.

In a daisy chain scenario, the last PB-9250J in the daisy chain that is connected to the backend PC should be configured according to the Normal Backup Mode. Daisy chaining PB-9250J results in larger capacitor and longer backup time. User can decide how many PB-9250J to daisy chain depend on their needs.

For Daisy Chain mode, you should use the power supply with 24V or higher voltage output. You can refer to the following table to determine the power requirements and numbers of daisy-chaining PB-9250J-SA.

Power Consumption of Back-end System	Output Voltage of Power Supply	Rated Current of Power Supply	PB-9250J-SA Charging Mode	Max. # of Daisy-chain
< 80 W	24 VDC or higher	8 A or higher	5 A	8
80 W ~ 180 W	24 VDC or higher	13 A or higher	10 A	4

3.3 Configuring Windows System

Please make sure you've configured your Windows system to initiate a shutdown process when pressing the power button. By default, Windows 7/ 8/ 10 goes to sleep (S3) mode when the power button is pressed. As sleep (S3) is not a complete shutdown behavior, therefore the PB standalone module will not recognize this command. To configure the setting in your Windows system, go to "Control Panel>System and Security>Power Options".



Set the "When I press the power button" configuration to "Shut down"

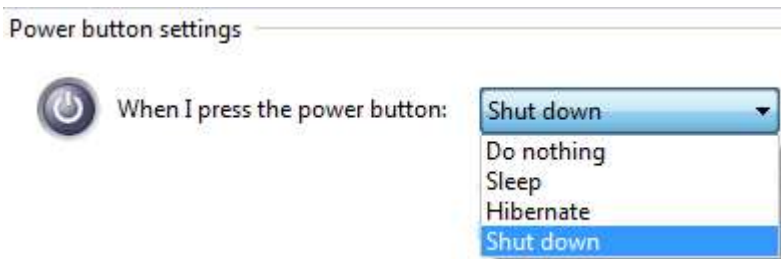

4 CAP Energy Management Technology ~ Power Backup Parameter Configurer

By controlling fundamental techniques such as charge/ discharge control, active load balance and DC/ DC regulation, Neousys is able to design and create a reliable ultracapacitor-based power backup system. However, the real challenge is how to get the most out of the capacitor energy while ensuring the system shuts down safely during a power blackout.

4.1 CAP Energy Management Technology

The patented architecture (R.O.C. patent I598820) incorporates a microprocessor along with supercapacitors and charge/ discharge controller. The proprietary firmware embedded in the MCU not only monitors energy level continuously, it also automatically initiates soft-shutdown to prevent data loss/ corruption.

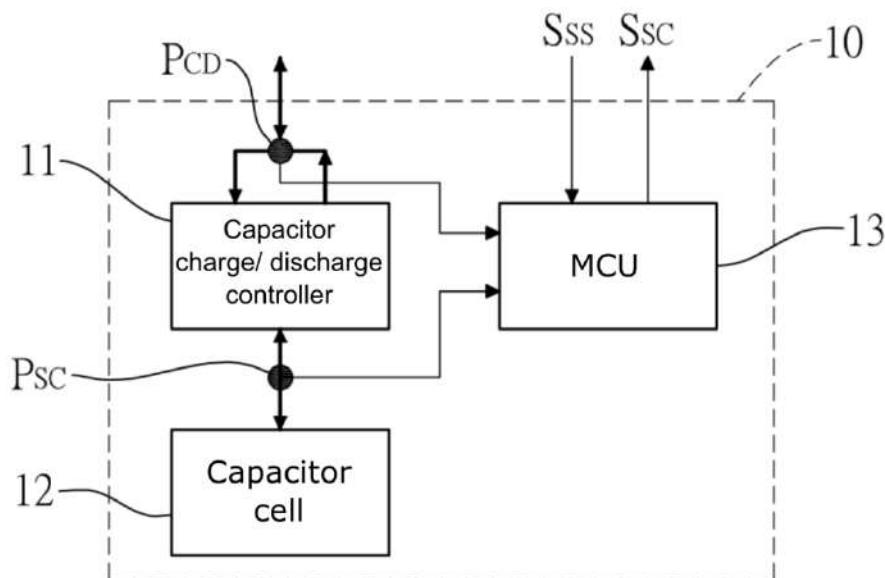

By providing sophisticated real-time energy monitoring, high/ low voltage protection and auto/ manual shutdown control, the dedicated interface help users better manage and efficiently utilize their PB standalone module. The software can also extend the lifespan of supercapacitors up to 4.8x by controlling charge/ discharge cycles.

4.2 Power Backup Parameter Configurer

4.2.1 Executing Power Backup Parameter Configurer

The Power Backup Parameter Configurer is an application that allows the user to monitor and manage the connected the PB standalone module.

Once you have setup the PB standalone module and have connected it to the host controller COM port (configured in RS-232 mode). You may run it by double clicking the exe file.

4.2.2 Connecting to COM 1 Port on Host Computer



NOTE

Please make sure the host system's COM port is configured to operate in RS-232 mode.

By default, Neousys_PB_Configurer.exe is designed to communicate with the PB standalone module via COM 1 port of the connected host computer. When successfully connected, the configurer should look similar to the following illustration.

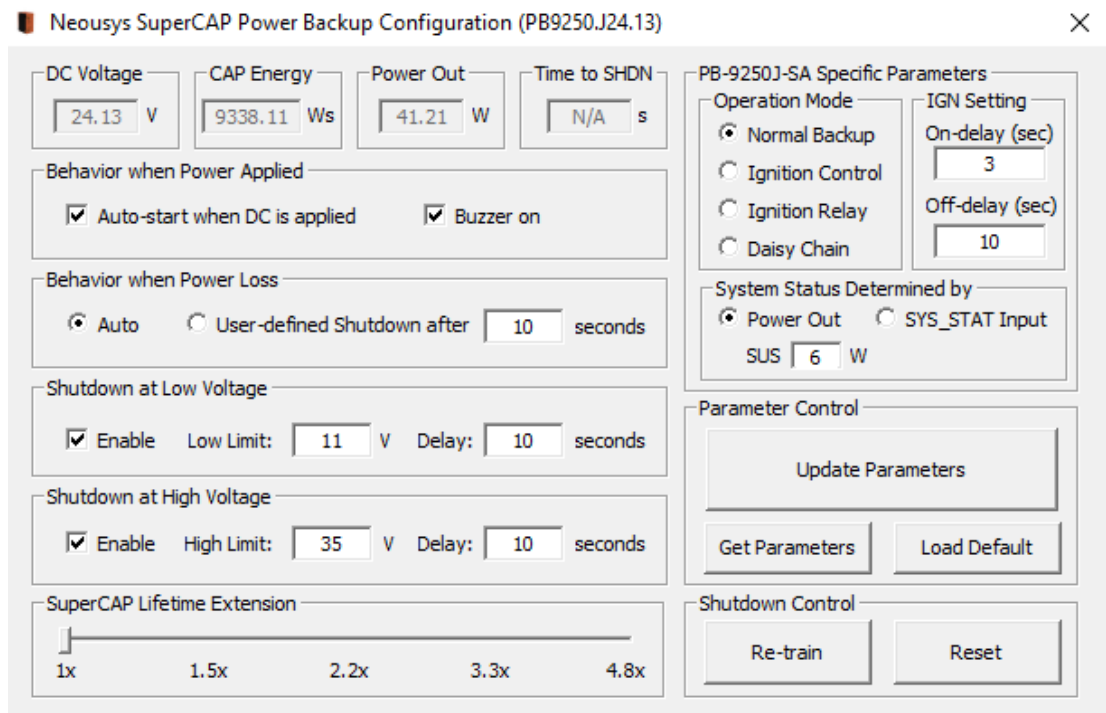

4.2.3 Connecting to a Different COM Port on Host Computer

If you wish to connect to another COM port (COM2, 3 or 4), you will need to reconfigure the connection setting or the configurer will read false readings (F/W Version, DC Voltage, CAP Energy) upon initial connection.

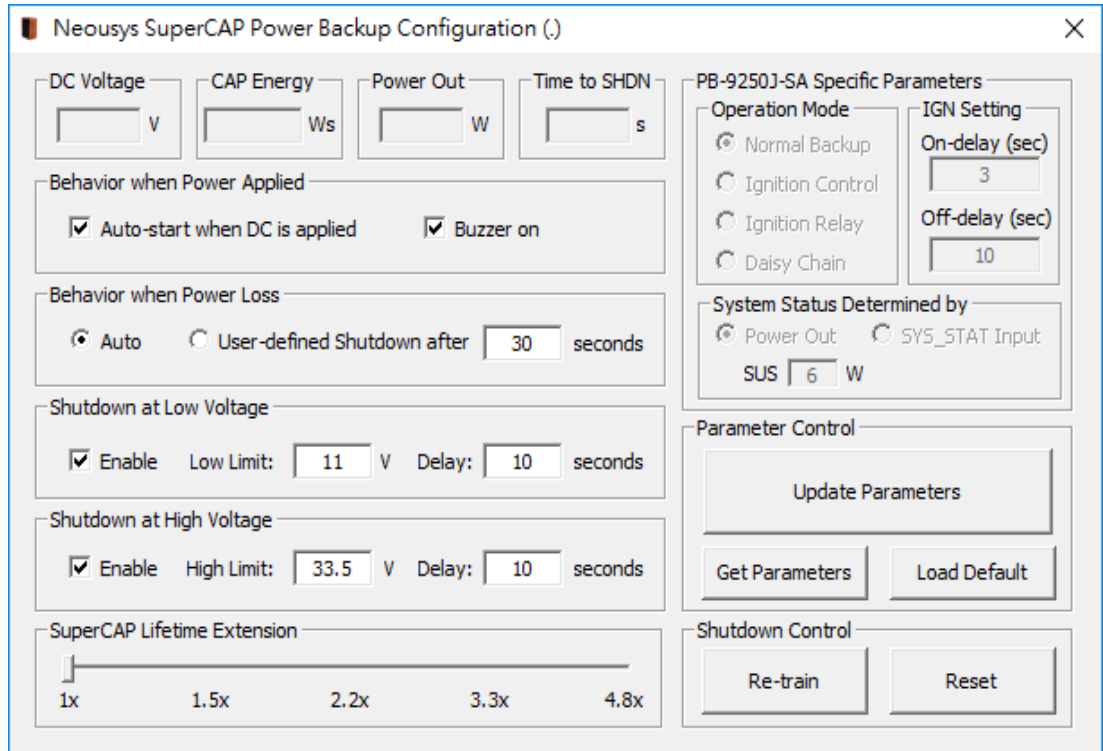

To complete the connection switch to the new COM port, the following steps must be performed in order for the system to read PB standalone module parameters.

1. Press Windows key
2. In the “Search programs and files” column, type in “cmd” and press Ctrl+Shift+Enter to run the “command line dialogue” with administrative rights
3. Change directory to where PB_Configurer.J25.19.exe can be located. For example, with the file PB_Configurer.J25.19.exe placed in the desktop and the newly connected port on the host computer is COM3.

```

C:\Windows\system32\cmd.exe
Microsoft Windows [Version 10.0.17763.107]
(c) 2018 Microsoft Corporation. All rights reserved.

C:\Users\NV7K>cd Desktop
C:\Users\NV7K\Desktop>
    
```

- Type in “PB_Configurer.J25.19.exe com3” (.exe file name + COM port number connected) and press Enter.

```

C:\Windows\system32\cmd.exe
Microsoft Windows [Version 10.0.17763.503]
(c) 2018 Microsoft Corporation. All rights reserved.

C:\Users\NV7K>cd Desktop

C:\Users\NV7K\Desktop>PB_Configurer.J25.19.exe com3
    
```

- Once the command has been issued, all parameters should be updated accordingly. If not, press “Get Parameters” on the configurator to acquire statuses.

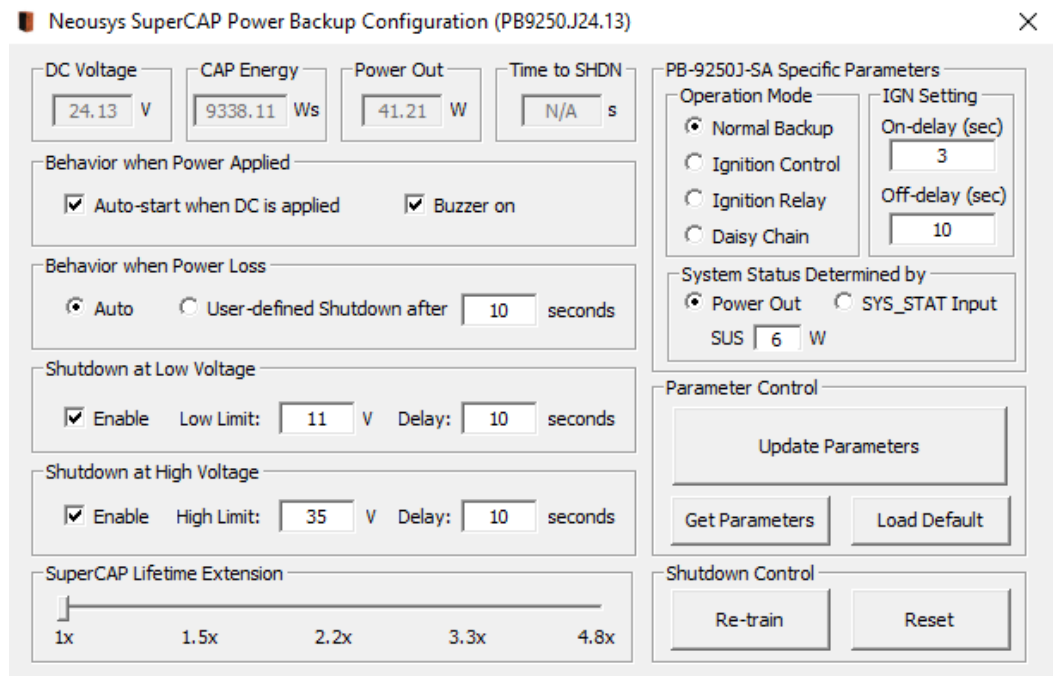

4.2.4 Power Backup Parameter Configurer Overview

Neosys SuperCAP Power Backup Configuration (PB9250J24.13) X

DC Voltage: V

CAP Energy: Ws

Power Out: W

Time to SHDN: s

Behavior when Power Applied

Auto-start when DC is applied Buzzer on

Behavior when Power Loss

Auto User-defined Shutdown after seconds

Shutdown at Low Voltage

Enable Low Limit: V Delay: seconds

Shutdown at High Voltage

Enable High Limit: V Delay: seconds

SuperCAP Lifetime Extension

1x 1.5x 2.2x 3.3x 4.8x

PB-9250J-SA Specific Parameters

Operation Mode

Normal Backup

Ignition Control

Ignition Relay

Daisy Chain

IGN Setting

On-delay (sec):

Off-delay (sec):

System Status Determined by

Power Out SYS_STAT Input

SUS: W

Parameter Control

Shutdown Control

Item	Description		
DC Voltage	Shows the current input voltage of your PB-9250J.		
CAP Energy	Shows the current charged energy status (rated 9250Ws Max.).		
Power Output	Shows the power draw of the back-end system.		
Time to SHDN	Shows the time in seconds, before shutdown is initiated.		
Parameter Configurer	Behavior when Power Applied	Auto start the back-end system once PB-9250J has been fully charged in Normal Backup Mode.	
	Behavior for Power Loss	This allows you to set the delay time (in seconds) to shutdown when DC voltage drops below 11V.	
	Shutdown at Low Voltage	This allows you set the low voltage limit and delay time (in seconds) to shutdown (Note: DO NOT set voltage lower than 11V).	
	Shutdown at High Voltage	This allows you set the high voltage limit and delay time (in seconds) to shutdown (Note: DO NOT set voltage higher than 35V).	
	Operation Mode	Normal Backup Mode	PB standalone module to operate in Normal Backup Mode when connected accordingly
		Ignition Control Mode	PB standalone module to operate in Ignition Control Mode when connected accordingly
		Ignition Relay Mode	PB standalone module to operate in Ignition Relay Mode when connected accordingly
		Daisy Chain Mode	PB-9250J to operate in Daisy Chain Mode when connected accordingly
IGN Setting	On-delay (sec)	This allows you to set the IGN delay time (in seconds) to turn on the system when PB standalone module is configured in Ignition Control Mode.	
	Off-delay (sec)	This allows you to set the IGN delay time (in seconds) to	

		shutdown the system when the PB standalone module is configured in Ignition Control Mode.
System Status Determined by	Power Out	Determines back-end system status via power draw/ consumption of back-end system. User can define the maximum stand by power draw/ consumption SUS__W of the connected PC (ex. If SUS defined at 6W, PB standalone module will assume the PC is running when it detects the power output is greater than 6W).
	SYS_STAT Input	Determines back-end system status via digital input signal pair into the PB standalone module (1: on/ 0: off).
Parameter Control	<p>Update Parameters: Click on this button for new parameters to take effect.</p> <p>Get Parameters: Click on this button to acquire current parameters.</p> <p>Load Default: Clicking on this button to load default parameters.</p>	
Shutdown Control	<p>Re-train: This button will re-train the PB standalone module to be customized to the system's required shutdown time.</p> <p>Reset: This button will reset (erase) previous Re-train shutdown settings.</p>	

4.2.5 Behavior when Power Applied

Neosys SuperCAP Power Backup Configuration (PB9250.J24.13) ✕

DC Voltage 24.13 V	CAP Energy 9338.11 Ws	Power Out 41.21 W	Time to SHDN N/A s	PB-9250J-SA Specific Parameters	
Behavior when Power Applied <input checked="" type="checkbox"/> Auto-start when DC is applied <input checked="" type="checkbox"/> Buzzer on				Operation Mode <input checked="" type="radio"/> Normal Backup <input type="radio"/> Ignition Control <input type="radio"/> Ignition Relay <input type="radio"/> Daisy Chain	IGN Setting On-delay (sec) <input type="text" value="3"/> Off-delay (sec) <input type="text" value="10"/>
Behavior when Power Loss <input checked="" type="radio"/> Auto <input type="radio"/> User-defined Shutdown after <input type="text" value="10"/> seconds				System Status Determined by <input checked="" type="radio"/> Power Out <input type="radio"/> SYS_STAT Input SUS <input type="text" value="6"/> W	
Shutdown at Low Voltage <input checked="" type="checkbox"/> Enable Low Limit: <input type="text" value="11"/> V Delay: <input type="text" value="10"/> seconds				Parameter Control <input type="button" value="Update Parameters"/> <input type="button" value="Get Parameters"/> <input type="button" value="Load Default"/>	
Shutdown at High Voltage <input checked="" type="checkbox"/> Enable High Limit: <input type="text" value="35"/> V Delay: <input type="text" value="10"/> seconds				Shutdown Control <input type="button" value="Re-train"/> <input type="button" value="Reset"/>	
SuperCAP Lifetime Extension <input type="range" value="1x"/> 1x 1.5x 2.2x 3.3x 4.8x					

Behavior when Power Applied

Auto-start when Power applied	If the “ Auto-start ” box is checked, the system will start after the PB standalone module has been fully charged when DC applied.
	If the “ Auto-start ” box is not checked, once you have plugged in the 3-pin pluggable terminal block (applied DC power input) and the PB standalone module is fully charged, you will need to press the power button to turn the system on.
Buzzer on	If the “ Buzzer on ” box is checked, a buzzer sound will sound as soon as the supercapacitors start to discharge (supplying power to the system).
	If the “ Buzzer on ” box is not checked, no buzzer sound will be made when the supercapacitors start to discharge.



NOTE

For new parameters to take effect, you must click on “[Update Parameters](#)” and follow procedure instructions. Please refer to the relevant section for details.

4.2.6 Behavior when Power Loss

Neosys SuperCAP Power Backup Configuration (PB9250J24.13) ✕

DC Voltage 24.13 V	CAP Energy 9338.11 Ws	Power Out 41.21 W	Time to SHDN N/A s
-----------------------	--------------------------	----------------------	-----------------------

Behavior when Power Applied

Auto-start when DC is applied Buzzer on

Behavior when Power Loss

Auto User-defined Shutdown after seconds

Shutdown at Low Voltage

Enable Low Limit: V Delay: seconds

Shutdown at High Voltage

Enable High Limit: V Delay: seconds

SuperCAP Lifetime Extension

1x 1.5x 2.2x 3.3x 4.8x

PB-9250J-SA Specific Parameters

Operation Mode

Normal Backup Ignition Control Ignition Relay Daisy Chain

IGN Setting

On-delay (sec)

Off-delay (sec)

System Status Determined by

Power Out SYS_STAT Input

SUS W

Parameter Control

Shutdown Control

Behavior when Power Loss Settings

Auto	If the “Auto” box is selected, the delay shutdown time will be pre-determined by the MCU when you “Re-train” the PB standalone module.
User-defined Shutdown after _ seconds	If the “User-defined Shutdown after _ seconds” is selected, when power loss, the shutdown process will be initiated by the user defined time in seconds.



NOTE

For new parameters to take effect, you must click on “[Update Parameters](#)” and follow procedure instructions. Please refer to the relevant section for details.

4.2.7 Shutdown at Low Voltage

Neosys SuperCAP Power Backup Configuration (PB9250.J24.13) ✕

DC Voltage: 24.13 V	CAP Energy: 9338.11 Ws	Power Out: 41.21 W	Time to SHDN: N/A s
---------------------	------------------------	--------------------	---------------------

Behavior when Power Applied

Auto-start when DC is applied Buzzer on

Behavior when Power Loss

Auto User-defined Shutdown after 10 seconds

Shutdown at Low Voltage

Enable Low Limit: 11 V Delay: 10 seconds

Shutdown at High Voltage

Enable High Limit: 35 V Delay: 10 seconds

SuperCAP Lifetime Extension

1x 1.5x 2.2x 3.3x 4.8x

PB-9250J-SA Specific Parameters

Operation Mode: Normal Backup Ignition Control Ignition Relay Daisy Chain

IGN Setting: On-delay (sec): 3 Off-delay (sec): 10

System Status Determined by: Power Out SYS_STAT Input

SUS: 6 W

Parameter Control

Update Parameters

Get Parameters Load Default

Shutdown Control

Re-train Reset

Shutdown at low Voltage

Enable	If the “ Enable ” box is checked, the shutdown process will be determined by the Low Limit: _ V and Delay: _ seconds.
Low Limit: _ V	If the “ Enable ” box is checked, the shutdown process will be initiated by low voltage limit setting (Low Limit: _ V) and the Delay: _ seconds.
Delay: _ seconds	If the “ Enable ” box is checked, the shutdown process will be initiated after _ seconds (Delay: _ seconds) when the low voltage limit setting (Low Limit: _ V) is reached.



NOTE

For new parameters to take effect, you must click on “[Update Parameters](#)” and follow procedure instructions. Please refer to the relevant section for details.

4.2.8 Shutdown at High Voltage

Neosys SuperCAP Power Backup Configuration (PB9250.J24.13) ✕

DC Voltage 24.13 V	CAP Energy 9338.11 Ws	Power Out 41.21 W	Time to SHDN N/A s	PB-9250J-SA Specific Parameters	
Behavior when Power Applied <input checked="" type="checkbox"/> Auto-start when DC is applied <input checked="" type="checkbox"/> Buzzer on				Operation Mode <input checked="" type="radio"/> Normal Backup <input type="radio"/> Ignition Control <input type="radio"/> Ignition Relay <input type="radio"/> Daisy Chain	
Behavior when Power Loss <input checked="" type="radio"/> Auto <input type="radio"/> User-defined Shutdown after 10 seconds				IGN Setting On-delay (sec) 3 Off-delay (sec) 10	
Shutdown at Low Voltage <input checked="" type="checkbox"/> Enable Low Limit: 11 V Delay: 10 seconds				System Status Determined by <input checked="" type="radio"/> Power Out <input type="radio"/> SYS_STAT Input SUS 6 W	
Shutdown at High Voltage <input checked="" type="checkbox"/> Enable High Limit: 35 V Delay: 10 seconds				Parameter Control Update Parameters Get Parameters Load Default	
SuperCAP Lifetime Extension 1x 1.5x 2.2x 3.3x 4.8x				Shutdown Control Re-train Reset	

Shutdown at High Voltage

Enable	If the “ Enable ” box is checked, the shutdown process will be determined by the High Limit: _ V and Delay: _ seconds settings.
High Limit: _ V	If the “ Enable ” box is checked, the shutdown process will be initiated by high voltage limit setting (High Limit: _ V) and the Delay: _ seconds.
Delay: _ seconds	If the “ Enable ” box is checked, the shutdown process will be initiated after _ seconds (Delay: _ seconds) when the high voltage limit setting (High Limit: _ V) is reached.



NOTE

For new parameters to take effect, you must click on “[Update Parameters](#)” and follow procedure instructions. Please refer to the relevant section for details.

4.2.9 SuperCAP Lifetime Extension

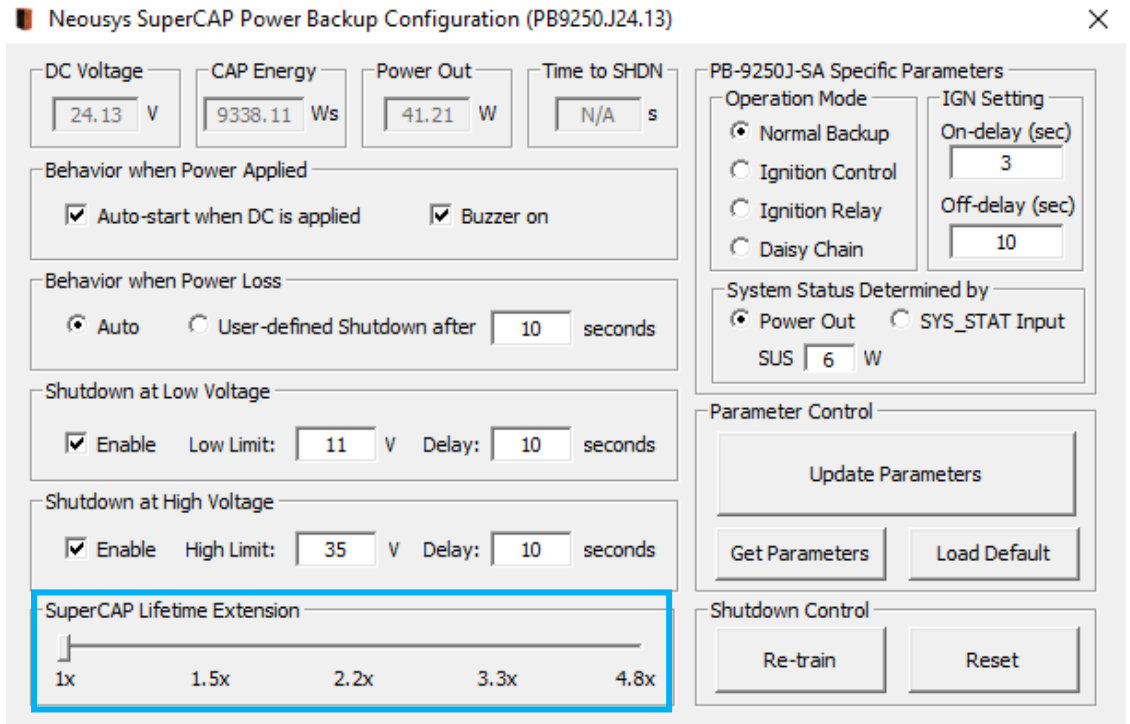

The SuperCAP lifetime extension setting is an automated setting when users only need to click on the bar, drag it to the desired lifetime extension setting, click on the “Update Parameters” and follow procedure instructions for settings to take effect.

SuperCAP Lifetime Extension

It is recommended to only use the SuperCAP Lifetime Extension to extend the lifetime if PB-9250J/ 4600J will be operating in high temperatures (>65°C) for long duration. The SuperCap lifetime can be extended by reducing SuperCap energy utilization. The following table shows the lifetime extension vs energy utilization vs hrs of operation (at 65°C)

SuperCAP Lifetime Extension	SuperCAP Energy Utilization(PB9250J-SA/ PB4600J-SA/ PB-2580J-SA)	SuperCAP Operation Lifespan
1x	9250w·s/ 4600 w·s/ 2500 w.s	34,000 hrs
1.5x	8524w·s/ 4240 w·s/ 2304 w.s	51,000 hrs
2.2x	7820 w·s/ 3890 w·s/ 2114 w.s	76,000 hrs
3.3x	7163 w·s/ 3560 w·s/ 1936 w.s	> 10 years
4.8x	6525 w·s/ 3245 w·s/ 1764 w.s	> 10 years



NOTE

For new parameters to take effect, you must click on “[Update Parameters](#)” and follow procedure instructions. Please refer to the relevant section for details.

4.2.10 Operation Mode

Neosys SuperCAP Power Backup Configuration (PB9250.J24.13) ✕

DC Voltage 24.13 V	CAP Energy 9338.11 Ws	Power Out 41.21 W	Time to SHDN N/A s	PB-9250J-SA Specific Parameters Operation Mode <input checked="" type="radio"/> Normal Backup <input type="radio"/> Ignition Control <input type="radio"/> Ignition Relay <input type="radio"/> Daisy Chain	
Behavior when Power Applied <input checked="" type="checkbox"/> Auto-start when DC is applied <input checked="" type="checkbox"/> Buzzer on				IGN Setting On-delay (sec) <input type="text" value="3"/> Off-delay (sec) <input type="text" value="10"/>	
Behavior when Power Loss <input checked="" type="radio"/> Auto <input type="radio"/> User-defined Shutdown after <input type="text" value="10"/> seconds				System Status Determined by <input checked="" type="radio"/> Power Out <input type="radio"/> SYS_STAT Input SUS <input type="text" value="6"/> W	
Shutdown at Low Voltage <input checked="" type="checkbox"/> Enable Low Limit: <input type="text" value="11"/> V Delay: <input type="text" value="10"/> seconds				Parameter Control <input type="button" value="Update Parameters"/> <input type="button" value="Get Parameters"/> <input type="button" value="Load Default"/>	
Shutdown at High Voltage <input checked="" type="checkbox"/> Enable High Limit: <input type="text" value="35"/> V Delay: <input type="text" value="10"/> seconds				Shutdown Control <input type="button" value="Re-train"/> <input type="button" value="Reset"/>	
SuperCAP Lifetime Extension <input type="range" value="1x"/> 1x 1.5x 2.2x 3.3x 4.8x					

Operation Mode

Normal Backup Mode	If “ Normal Backup Mode ” box is selected, PB standalone module will operate in Normal Backup Mode .
Ignition Control Mode	If “ Ignition Control Mode ” box is selected, PB standalone module will operate in Ignition Control Mode .
Ignition Relay Mode	If “ Ignition Relay Mode ” box is selected, PB standalone module will operate in Ignition Relay Mode .
Daisy Chain Mode (applicable to PB-9250J-SA only)	If “ Daisy Chain Mode ” box is selected, PB-9250J will operate in Daisy Chain Mode .



NOTE

For new parameters to take effect, you must click on “[Update Parameters](#)” and follow procedure instructions. Please refer to the relevant section for details.

4.2.11 IGN Setting

Neosys SuperCAP Power Backup Configuration (PB9250.J24.13) ✕

DC Voltage 24.13 V	CAP Energy 9338.11 Ws	Power Out 41.21 W	Time to SHDN N/A s	PB-9250J-SA Specific Parameters Operation Mode <input checked="" type="radio"/> Normal Backup <input type="radio"/> Ignition Control <input type="radio"/> Ignition Relay <input type="radio"/> Daisy Chain System Status Determined by <input checked="" type="radio"/> Power Out <input type="radio"/> SYS_STAT Input SUS 6 W	
Behavior when Power Applied <input checked="" type="checkbox"/> Auto-start when DC is applied <input checked="" type="checkbox"/> Buzzer on				IGN Setting On-delay (sec) 3 Off-delay (sec) 10	
Behavior when Power Loss <input checked="" type="radio"/> Auto <input type="radio"/> User-defined Shutdown after 10 seconds				Parameter Control Update Parameters Get Parameters Load Default	
Shutdown at Low Voltage <input checked="" type="checkbox"/> Enable Low Limit: 11 V Delay: 10 seconds				Shutdown Control Re-train Reset	
Shutdown at High Voltage <input checked="" type="checkbox"/> Enable High Limit: 35 V Delay: 10 seconds					
SuperCAP Lifetime Extension 1x 1.5x 2.2x 3.3x 4.8x					

If the PB standalone module is in Ignition Control Mode, user can set IGN on/off delay via IGN setting.

On-delay (sec)	The PWRBTN# signal will be sent after _ seconds (Delay: _ seconds) after the PB standalone module is fully charged to turn on the back-end system.
Off-delay (sec)	The PWRBTN# signal will be sent after _ seconds (Delay: _ seconds) to turn off the back-end system after IGN in signal has been cut off.



NOTE

For new parameters to take effect, you must click on “[Update Parameters](#)” and follow procedure instructions. Please refer to the relevant section for details.

4.2.12 System Status Determined by

Neosys SuperCAP Power Backup Configuration (PB9250J24.13) ✕

DC Voltage 24.13 V	CAP Energy 9338.11 Ws	Power Out 41.21 W	Time to SHDN N/A s	PB-9250J-SA Specific Parameters	
Behavior when Power Applied <input checked="" type="checkbox"/> Auto-start when DC is applied <input checked="" type="checkbox"/> Buzzer on				Operation Mode <input checked="" type="radio"/> Normal Backup <input type="radio"/> Ignition Control <input type="radio"/> Ignition Relay <input type="radio"/> Daisy Chain	IGN Setting On-delay (sec) 3 Off-delay (sec) 10
Behavior when Power Loss <input checked="" type="radio"/> Auto <input type="radio"/> User-defined Shutdown after 10 seconds				System Status Determined by <input checked="" type="radio"/> Power Out <input type="radio"/> SYS_STAT Input SUS 6 W	
Shutdown at Low Voltage <input checked="" type="checkbox"/> Enable Low Limit: 11 V Delay: 10 seconds				Parameter Control <input type="button" value="Update Parameters"/> <input type="button" value="Get Parameters"/> <input type="button" value="Load Default"/>	
Shutdown at High Voltage <input checked="" type="checkbox"/> Enable High Limit: 35 V Delay: 10 seconds				Shutdown Control <input type="button" value="Re-train"/> <input type="button" value="Reset"/>	
SuperCAP Lifetime Extension 1x 1.5x 2.2x 3.3x 4.8x					

The PB standalone module has to monitor back-end system status (whether it's on or off) in order to make the right operation in different situation.

Power Out	System status is determined by the power draw/ consumption of back-end system. User can define the maximum standby power draw/ consumption SUS__W of the connected PC (ex. If SUS is defined at 6W, the PB standalone module will consider the PC is running when it detects the power output is greater than 6W).
SYS_STAT Input	System status is determined by the input digital signal pair given by back-end system (1: on/ 0: off).



NOTE

For new parameters to take effect, you must click on "[Update Parameters](#)" and follow procedure instructions. Please refer to the relevant section for details.

4.2.13 Update Parameters

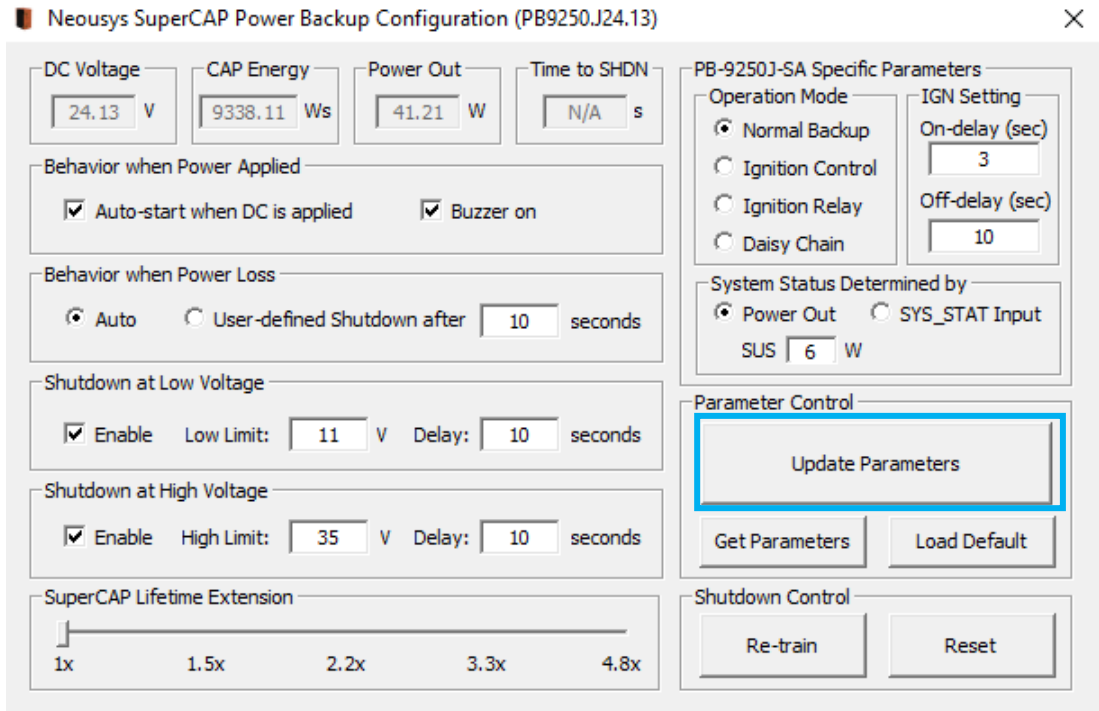

Whenever you enter/ adjust a new parameter or parameters, for the new settings to take effect, you must perform the following steps:

1. Click on the “Update Parameters” button and the following dialogue will appear.

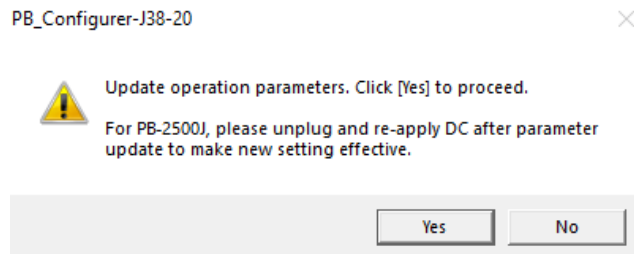

2. Click on yes, the PB standalone module will automatically shutdown the system.
3. Once the system has shut down, wait for 1~3 sec and the PB standalone module will automatically restart.
4. New settings will apply upon restart.

4.2.14 Get Parameters

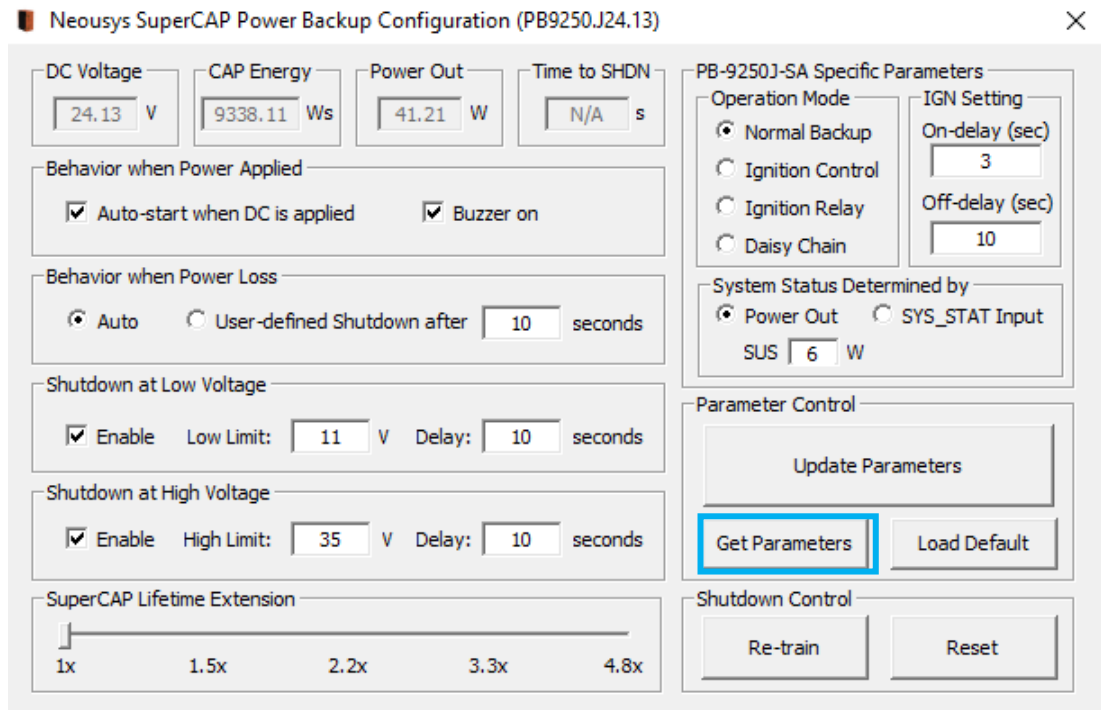

Neosys SuperCAP Power Backup Configuration (PB9250.J24.13)

DC Voltage: 24.13 V | CAP Energy: 9338.11 Ws | Power Out: 41.21 W | Time to SHDN: N/A s

Behavior when Power Applied: Auto-start when DC is applied | Buzzer on

Behavior when Power Loss: Auto | User-defined Shutdown after 10 seconds

Shutdown at Low Voltage: Enable | Low Limit: 11 V | Delay: 10 seconds

Shutdown at High Voltage: Enable | High Limit: 35 V | Delay: 10 seconds

SuperCAP Lifetime Extension: 1x | 1.5x | 2.2x | 3.3x | 4.8x

PB-9250J-SA Specific Parameters

Operation Mode: Normal Backup | Ignition Control | Ignition Relay | Daisy Chain

IGN Setting: On-delay (sec): 3 | Off-delay (sec): 10

System Status Determined by: Power Out | SYS_STAT Input | SUS: 6 W

Parameter Control: Update Parameters | **Get Parameters** | Load Default

Shutdown Control: Re-train | Reset

Click on “Get Parameters” to manually acquire the current the PB standalone module status for DC voltage, current stored CAP energy and power output.

4.2.15 Load Default

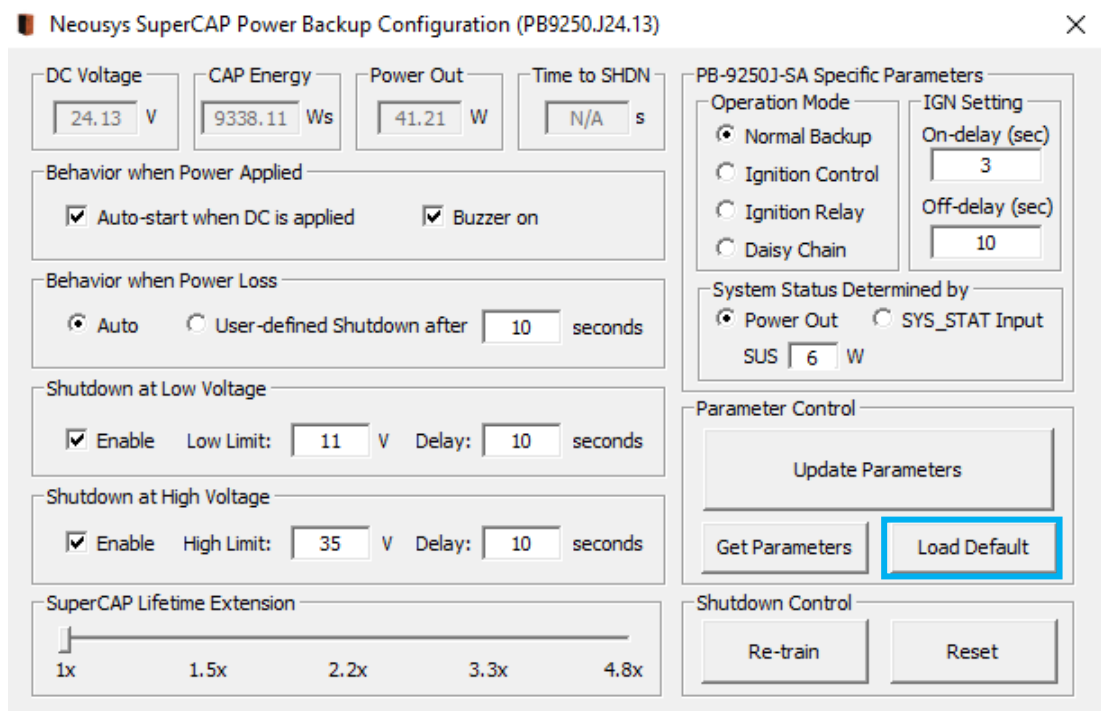

Neosys SuperCAP Power Backup Configuration (PB9250.J24.13)

DC Voltage: 24.13 V | CAP Energy: 9338.11 Ws | Power Out: 41.21 W | Time to SHDN: N/A s

Behavior when Power Applied: Auto-start when DC is applied | Buzzer on

Behavior when Power Loss: Auto | User-defined Shutdown after 10 seconds

Shutdown at Low Voltage: Enable | Low Limit: 11 V | Delay: 10 seconds

Shutdown at High Voltage: Enable | High Limit: 35 V | Delay: 10 seconds

SuperCAP Lifetime Extension: 1x | 1.5x | 2.2x | 3.3x | 4.8x

PB-9250J-SA Specific Parameters

Operation Mode: Normal Backup | Ignition Control | Ignition Relay | Daisy Chain

IGN Setting: On-delay (sec): 3 | Off-delay (sec): 10

System Status Determined by: Power Out | SYS_STAT Input | SUS: 6 W

Parameter Control: Update Parameters | Get Parameters | **Load Default**

Shutdown Control: Re-train | Reset

You may set the PB standalone module back to the original settings by clicking on “Load Default” to reset all changes you have made previously.

4.2.16 Re-train

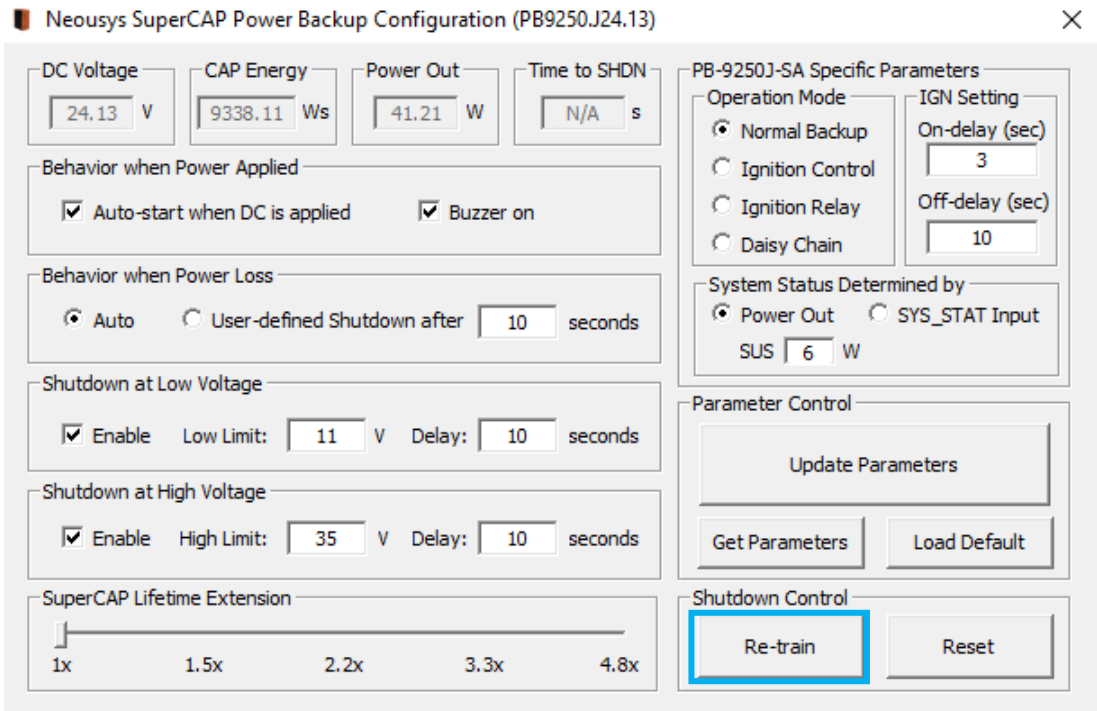

Neosys SuperCAP Power Backup Configuration (PB9250.J24.13)

DC Voltage: 24.13 V | CAP Energy: 9338.11 Ws | Power Out: 41.21 W | Time to SHDN: N/A s

Behavior when Power Applied: Auto-start when DC is applied | Buzzer on

Behavior when Power Loss: Auto | User-defined Shutdown after 10 seconds

Shutdown at Low Voltage: Enable | Low Limit: 11 V | Delay: 10 seconds

Shutdown at High Voltage: Enable | High Limit: 35 V | Delay: 10 seconds

SuperCAP Lifetime Extension: 1x | 1.5x | 2.2x | 3.3x | 4.8x

PB-9250J-SA Specific Parameters

Operation Mode: Normal Backup | Ignition Control | Ignition Relay | Daisy Chain

IGN Setting: On-delay (sec): 3 | Off-delay (sec): 10

System Status Determined by: Power Out | SYS_STAT Input | SUS: 6 W

Parameter Control: Update Parameters | Get Parameters | Load Default

Shutdown Control: **Re-train** | Reset

The Re-train function is to customize the PB standalone module to your system’s required shutdown time! By clicking on “Re-train”, a shutdown action will be initiated so the time required to shutdown can be memorized.

4.2.17 Reset

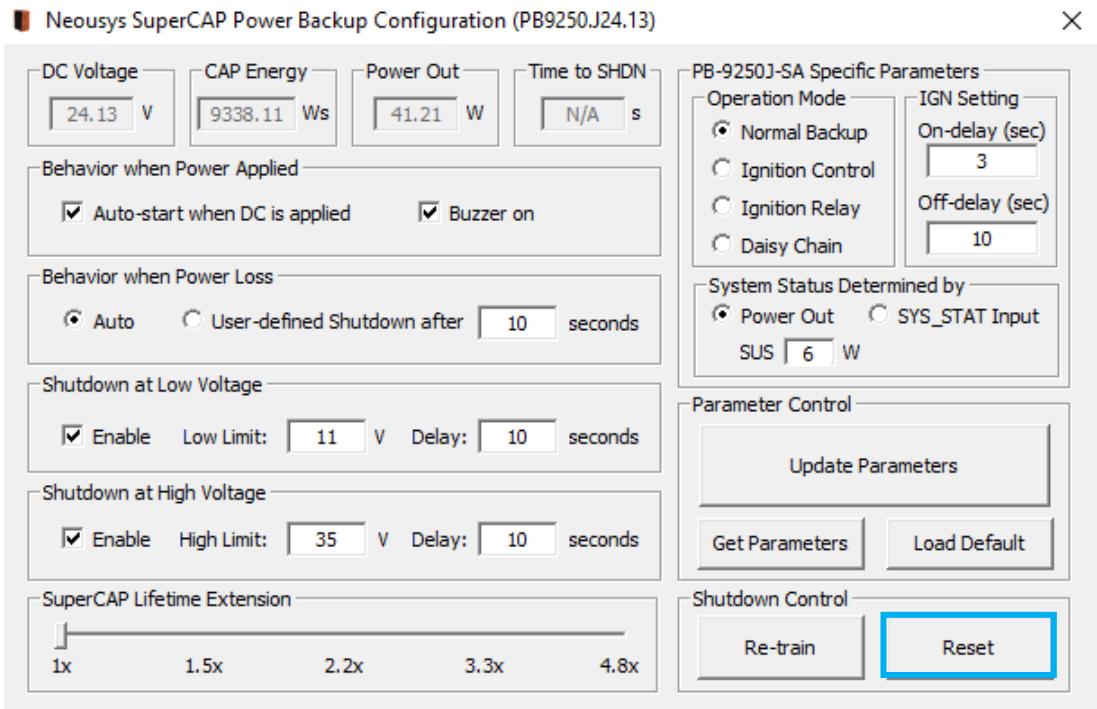

Neosys SuperCAP Power Backup Configuration (PB9250.J24.13)

DC Voltage: 24.13 V | CAP Energy: 9338.11 Ws | Power Out: 41.21 W | Time to SHDN: N/A s

Behavior when Power Applied: Auto-start when DC is applied | Buzzer on

Behavior when Power Loss: Auto | User-defined Shutdown after 10 seconds

Shutdown at Low Voltage: Enable | Low Limit: 11 V | Delay: 10 seconds

Shutdown at High Voltage: Enable | High Limit: 35 V | Delay: 10 seconds

SuperCAP Lifetime Extension: 1x | 1.5x | 2.2x | 3.3x | 4.8x

PB-9250J-SA Specific Parameters

Operation Mode: Normal Backup | Ignition Control | Ignition Relay | Daisy Chain

IGN Setting: On-delay (sec): 3 | Off-delay (sec): 10

System Status Determined by: Power Out | SYS_STAT Input | SUS: 6 W

Parameter Control: Update Parameters | Get Parameters | Load Default

Shutdown Control: Re-train | **Reset**

By clicking on Reset, it will erase all previous Re-train settings and hence result in faster shutdown when a command is issued.

4.3 Estimated Extended Operation Time

Utilizing state-of-the-art supercapacitor technology, the Neousys PB standalone module is a standalone power backup module that can protect your box-PC against power outages. It can reliably operate in harsh environments from -25 to 65°C, and have extremely high durability lasting up to 10 years. It serves as a maintenance-free energy storage and uninterruptible power supply to your connected back-end system and can prevent data loss during power outage in harsh industrial environments!

Using PB-9250J-SA as an example, below is an estimated extended operation time one can expect for the connected back-end system during unforeseen power outage events. The actual extended operation time may vary depending on your connected back-end system hardware configuration.

Power consumption of back-end system	Backup Time
150 Watts	10.95 Seconds
130 Watts	13.76 Seconds
110 Watts	21.2 Seconds
90 Watts	30.42 Seconds
70 Watts	40.39 Seconds
50 Watts	59.28 Seconds
30 Watts	98.86 Seconds
10 Watts	289.15 Seconds

4.4 PB-9250J-SA/ PB-9250J-110V Output Voltage Drop

Due to hardware limitations, at the moment when input power supply is removed, the output voltage will have a voltage drop where the duration of the voltage drop may last up to 450ms. The minimum voltage output (caused by the voltage drop) will vary depending on the input wattage. For the approximate minimum voltage output during the voltage drop, please refer to following table:

Input Wattage (W)	Approximate Minimum Voltage Output (V) During Voltage Drop
10W	20.19V
20W	19.94V
30W	19.63V
40W	19.36V
50W	19.19V
60W	18.94V
70W	18.75V
80W	18.5V
90W	18.25V
100W	18.06V
110W	17.94V
120W	17.81
130W	17.63
140W	17.31
150W	17.19